

Since 1981
Desde 1981

For a Sustainable Future

Catalog 2023

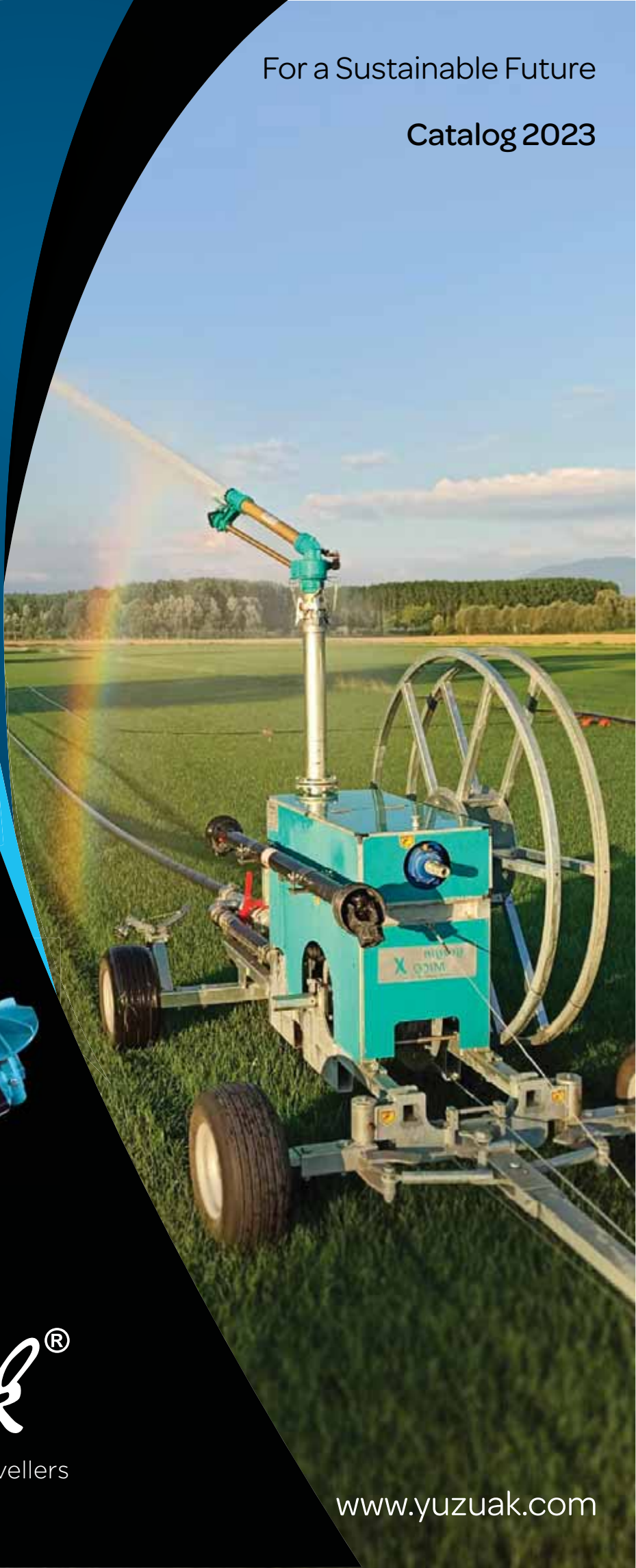
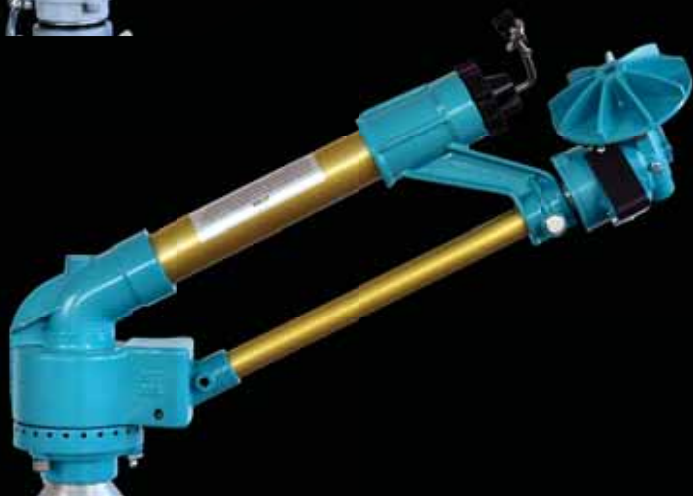

yuzuak[®]
Sprinklers & Travellers

www.yuzuak.com

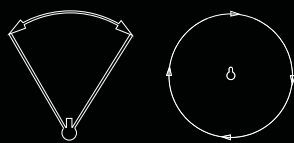

Part circle and Full circle

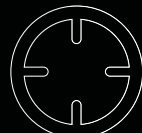

Barrel cross section

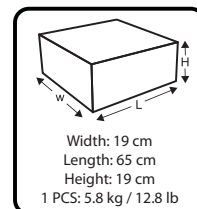

Water Input / El agua de entrada: 1,5"
 Working Pressure / Presión de trabajo: 2 – 6 kg/cm²
 Water Requirement / Requerimientos de agua: 6,5 m³/h – 32,2 m³/h
 Nozzles / Boquilla: 10mm – 12mm – 14mm – 16mm – 18mm
 Body Angle / Cuerpo Ángulo: 28°

JET30S											
Nozzle diameter Diamètre de la bluse Diámetro de la tobera Durchmesser der Hauptdüse Diametro ugello		Pressure Pression Presi òn Wasserdruck im Beregner Pressione		Jet Length Portée Chorro Tragweite Gittata		Capacity Débit Capacidad Kapazität Portata			Values for a single sprinkler Données pour 1 arros. tout seul Datos para cada rociador Technische Daten für Einzelberegne Dati relativi ad 1 irrigatore		
									Irrigated area Surface arrosée Superficie irrigada Beregnete Fläche Superficie irrigata		Rainfall per hour Pluviométrie horaire Intensidad horaira Wassermenge pro Stund Intensità oraria
mm	inch	kg/cm ²	lbs/inch	m	feet	l/min	m ³ /h	G.P.M.	m ²	acre	mm/h
10	.39	2	29	18	59	108	6.5	29	1017	0.25	6.4
	.39	3	44	21	69	125	7.5	33	1385	0.34	5.4
	.39	4	56	23	75	143	8.6	38	1661	0.41	5.2
12	.47	2	29	20	66	140	8.4	37	1256	0.31	6.7
	.47	3	44	23	75	165	9.9	44	1661	0.41	6.0
	.47	4	56	25	82	192	11.5	51	1963	0.48	5.9
14	.55	3	44	24	79	238	14.3	63	1809	0.45	7.9
	.55	4	56	26	85	283	17	75	2123	0.52	8.0
	.55	5	70	29	95	303	18.2	80	2641	0.65	6.9
16	.62	3	44	28	92	303	18.2	80	2462	0.61	7.4
	.62	4	56	31	102	352	21.1	93	3018	0.75	7.0
	.62	5	70	33	108	392	23.5	103	3419	0.84	6.9
18	.70	3	85	30	98	367	22	97	2826	0.70	7.8
	.70	4	85	32	105	438	26.3	116	3215	0.79	8.2
	.70	5	85	34	112	492	29.5	130	3630	0.90	8.1
	.70	6	85	36	118	537	32.2	142	4069	1.01	7.9

The technical tables was created in zero wind conditions. The test tripod height is 1.2 Meters / Se crearon tablas técnicas en condiciones de viento cero. La altura del trípode de prueba es de 1,2 metros.

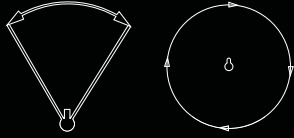

Part circle and Full circle

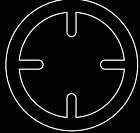

Barrel cross section

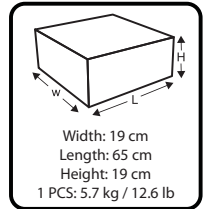

JET 35

Water Input / El agua de entrada: 1,5"
 Working Pressure / Presión de trabajo: 2 – 6 kg/cm²
 Water Requirement / Requerimientos de agua: 6,5 m³/h – 32 m³/h
 Nozzles / Boquilla: 10mm – 12mm – 14mm – 16mm – 18mm
 Body Angle / Cuerpo Ángulo: 24°

Jet 35											
Nozzle diameter Diamètre de la bluse Diámetro de la tobera Durchmesser der Hauptdüse Diametro ugello		Pressure Pression Presión Wasserdruck im Beregner Pressione		Jet Length Portée Chorro Tragweite Gittata		Capacity Débit Capacidad Kapazität Portata			Values for a single sprinkler Données pour 1 arros. tout seul Datos para cada rociador Technische Daten für Einzelberegner Dati relativi ad 1 irrigatore		
									Irrigated area Surface arrosée Superficie irrigada Beregnete Fläche Superficie irrigata		Rainfall per hour Pluviométrie horaire Intensidad horaira Wassermenge pro Stund Intensità oraria
mm	inch	kg/cm ²	lbs/inch	m	feet	l/min	m ³ /h	G.P.M.	m ²	acre	mm/h
10	.39	2	29	19	62	108	6.5	29	1134	0.28	5.7
	.39	3	44	21	69	125	7.5	33	1385	0.34	5.4
	.39	4	56	23	75	143	8.6	38	1661	0.41	5.2
12	.47	2	29	21	69	152	9.1	40	1385	0.34	6.6
	.47	3	44	24	79	182	10.9	48	1809	0.45	6.0
	.47	4	56	27	89	210	12.6	55	2289	0.57	5.5
	.47	5	30	30	98	235	14.1	62	2826	0.70	4.99
14	.55	2	29	21	69	195	11.7	52	1385	0.34	8.45
	.55	3	44	25	82	238	14.3	63	1963	0.48	7.3
	.55	4	56	29	95	277	16.6	73	2641	0.65	6.3
	.55	5	70	31	102	308	18.5	81	3018	0.75	6.1
16	.62	2	29	22	72	247	14.8	65	1520	0.38	9.7
	.62	3	44	26	85	303	18.2	80	2123	0.52	8.6
	.62	4	56	30	98	350	21	92	2826	0.70	7.4
	.62	5	70	33	108	390	23.4	103	3419	0.84	6.8
18	.70	3	44	28	92	378	22.7	100	2462	0.61	9.2
	.70	4	56	31	102	437	26.2	115	3018	0.75	8.7
	.70	5	70	34	112	487	29.2	129	3630	0.90	8.0
	.70	6	85	36	118	532	31.9	140	4069	1.01	7.8

The technical tables was created in zero wind conditions. The test tripod height is 1.2 Meters / Se crearon tablas técnicas en condiciones de viento cero. La altura del trípode de prueba es de 1,2 metros.

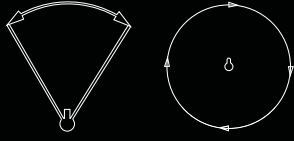

Part circle and Full circle

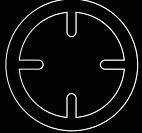

Barrel cross section

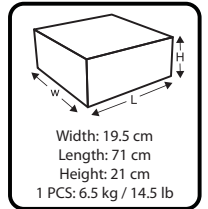

JET 40

Water Input / El agua de entrada: 2"
 Working Pressure / Presión de trabajo: 2 – 6 kg/cm²
 Water Requirement / Requerimientos de agua: 9 m³/h – 44 m³/h
 Nozzles / Boquilla: 10mm – 12mm – 14mm – 16mm – 18mm – 20mm – 22mm
 Body Angle / Cuerpo Ángulo: 25°

JET40												
Nozzle diameter Diamètre de la bluse Diámetro de la tobera Durchmesser der Hauptdüse Diametro ugello		Pressure Pression Presión Wasserdruck im Beregner Pressione		Jet Length Portée Chorro Tragweite Gittata		Capacity Débit Capacidad Kapazität Portata			Values for a single sprinkler Données pour 1 arros. tout seul Datos para cada rociador Technische Daten für Einzelberegner Dati relativi ad 1 irrigatore			
									Irrigated area Surface arrosée Superficie irrigada Beregnete Fläche Superficie irrigata		Rainfall per hour Pluviométrie horaire Intensidad horaira Wassermenge pro Stund Intensità oraria	
mm	inch	kg/cm ²	lbs/inch	m	feet	l/min	m ³ /h	G.P.M.	m ²	acre	mm/h	
12	.47	2	29	24	79	140	8.4	37	1809	0.45	4.6	
	.47	3	44	29	95	165	9.9	44	2641	0.65	3.7	
	.47	4	56	31	102	192	11.5	51	3018	0.75	3.8	
14	.55	3	56	30	98	238	14.3	63	2826	0.70	5.1	
	.55	4	70	31	102	283	17	75	3018	0.75	5.6	
	.55	5	85	35	115	303	18.2	80	3847	0.95	4.7	
16	.62	3	56	32	105	303	18.2	80	3215	0.79	5.7	
	.62	4	70	35	115	352	21.1	93	3847	0.95	5.5	
	.62	5	85	38	125	392	23.5	103	4534	1.12	5.2	
18	.70	3	85	33	108	367	22	97	3419	0.84	6.4	
	.70	4	85	36	118	438	26.3	116	4069	1.01	6.5	
	.70	5	85	40	131	492	29.5	130	5024	1.24	5.9	
20	.78	3	85	35	115	450	27	119	3847	0.95	7.0	
	.78	4	85	39	128	525	31.5	139	4776	1.18	6.6	
	.78	5	85	43	141	600	36	159	5806	1.43	6.2	
22	.86	4	85	40	131	633	38	167	5024	1.24	7.6	
	.86	5	85	44	144	700	42	185	6079	1.50	6.9	
	.86	6	85	45	148	733	44	194	6359	1.57	6.9	

The technical tables was created in zero wind conditions. The test tripod height is 1.2 Meters / Se crearon tablas técnicas en condiciones de viento cero. La altura del trípode de prueba es de 1,2 metros.

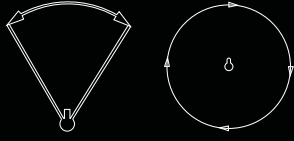

Part circle and Full circle

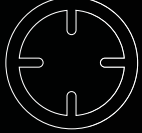

Barrel cross section

CIT* tested	Jet 50	△ 50 x 50m
	CU in %	89
	DU in %	85

*Center of Irrigation Technologies
Fresno, California/USA

¹⁾Nozzle Size 20mm 5 bar

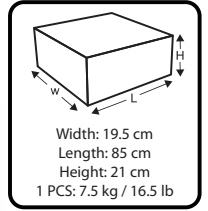

JET 50

Water Input / El agua de entrada: 2 "
Working Pressure / Presión de trabajo: 2 – 6 kg/cm²
Water Requirement / Requerimientos de agua: 14,0 m³/h – 61 m³/h
Nozzles / Boquilla: 14mm – 16mm – 18mm – 20mm – 22mm– 24mm
Body Angle / Cuerpo Ángulo: 25°

JET50											
Nozzle diameter Diamètre de la bluse Diámetro de la tobera Durchmesser der Hauptdüse Diametro ugello		Pressure Pression Presión Wasserdruck im Beregnere Pressione		Jet Length Portée Chorro Tragweite Gittata		Capacity Débit Capacidad Kapazität Portata			Values for a single sprinkler Données pour 1 arros. tout seul Datos para cada rociador Technische Daten für Einzelberegnere Dati relativi ad 1 irrigatore		
									Irrigated area Surface arrosée Superficie irrigada Beregnete Fläche Superficie irrigata		Rainfall per hour Pluviométrie horaire Intensidad horaira Wassermenge pro Stund Intensità oraria
mm	inch	kg/cm ²	lbs/inch	m	feet	l/min	m ³ /h	G.P.M.	m ²	acre	mm/h
14	.55	3	44	28	92	247	14.8	65	2462	0.61	6.0
	.55	4	56	31	102	287	17.2	76	3018	0.75	5.7
	.55	5	70	33	108	315	18.9	83	3419	0.84	5.5
16	.62	3	44	30	98	308	18.5	81	2826	0.70	6.5
	.62	4	56	33	108	358	21.5	95	3419	0.84	6.3
	.62	5	70	35	115	392	23.5	103	3847	0.95	6.1
18	.70	3	44	32	105	390	23.4	103	3215	0.79	7.3
	.70	4	56	35	115	445	26.7	118	3847	0.95	6.9
	.70	5	70	38	125	498	29.9	132	4534	1.12	6.6
	.70	6	85	41	134	553	33.2	146	5278	1.30	6.3
20	.78	3	44	35	115	463	27.8	122	3847	0.95	7.2
	.78	4	56	38	125	548	32.9	145	4534	1.12	7.3
	.78	5	70	42	138	617	37	163	5539	1.37	6.7
22	.86	4	56	40	131	680	40.8	180	5024	1.24	8.1
	.86	5	70	44	144	753	45.2	199	6079	1.50	7.4
	.86	6	85	47	154	818	49.1	216	6936	1.71	7.1
24	.94	5	70	46	151	887	53.2	234	6644	1.64	8.0
	.94	6	85	48	157	958	57.5	253	7235	1.79	7.9
	.94	7	100	50	164	1020	61.2	269	7850	1.94	7.8

The technical tables was created in zero wind conditions. The test tripod height is 1.2 Meters / Se crearon tablas técnicas en condiciones de viento cero. La altura del trípode de prueba es de 1,2 metros.

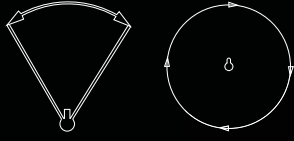

Part circle and Full circle

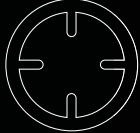

Barrel cross section

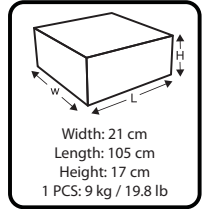

JET 55

Water Input / El agua de entrada: 2,5"
 Working Pressure / Presión de trabajo: 3 – 6 kg/cm²
 Water Requirement / Requerimientos de agua: 28 m³/h – 82 m³/h
 Nozzles / Boquilla: 20mm – 22mm – 24mm – 26mm – 28mm
 Body Angle / Cuerpo Ángulo: 25°

JET55												
Nozzle diameter Diamètre de la bluse Diámetro de la tobera Durchmesser der Hauptdüse Diametro ugello		Pressure Pression Presión Wasserdruck im Beregner Pressione		Jet Length Portée Chorro Tragweite Gittata		Capacity Débit Capacidad Kapazität Portata			Values for a single sprinkler Données pour 1 arros. tout seul Datos para cada rociador Technische Daten für Einzelberegner Dati relativi ad 1 irrigatore			
									Irrigated area Surface arrosée Superficie irrigada Beregnete Fläche Superficie irrigata		Rainfall per hour Pluviométrie horaire Intensidad horaira Wassermenge pro Stund Intensità oraria	
mm	inch	kg/cm ²	lbs/inch	m	feet	l/min	m ³ /h	G.P.M.	m ²	acre	mm/h	
20	.78	3	44	35	115	463	28	122	3847	0.95	7.2	
	.78	4	56	38	125	548	33	145	4534	1.12	7.3	
	.78	5	70	42	138	617	37	163	5539	1.37	6.7	
22	.86	4	56	40	131	680	41	180	5024	1.24	8.1	
	.86	5	70	44	144	753	45	199	6079	1.50	7.4	
	.86	6	85	47	154	818	49	216	6936	1.71	7.1	
24	.94	5	70	46	151	887	53	234	6644	1.64	8.0	
	.94	6	85	48	157	958	58	253	7235	1.79	7.9	
	.94	7	100	50	164	1020	61	269	7850	1.94	7.8	
26	1	4	56	45	148	867	52	229	6359	1.57	8.2	
	1	5	70	48	157	967	58	255	7235	1.79	8.0	
	1	6	85	51	167	1067	64	282	8167	2.02	7.8	
28	1.1	5	70	50	164	1117	67	295	7850	1.94	8.5	
	1.1	6	85	53	174	1233	74	326	8820	2.18	8.4	
	1.1	7	100	55	180	1358	82	359	9499	2.35	8.6	

The technical tables was created in zero wind conditions. The test tripod height is 1.2 Meters / Se crearon tablas técnicas en condiciones de viento cero. La altura del trípode de prueba es de 1,2 metros.

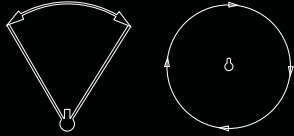

Part circle and Full circle

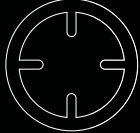

Barrel cross section

CIT* tested	65	△ 50 x 50m
	CU in %	87
	DU in %	78
*Center of Irrigation Technologies Fresno, California/USA		
1) Nozzle Size 24mm 5 bar		

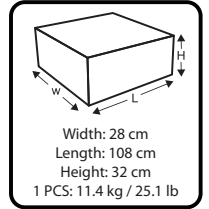

JET 65

Water Input / El agua de entrada: Flange 130mm x 78 mm"
 Working Pressure / Presión de trabajo: 3 – 7 kg/cm²
 Water Requirement / Requerimientos de agua: 23 m³/h – 108 m³/h
 Nozzles / Boquilla: 18mm – 20mm – 22mm – 24mm – 26mm – 28mm– 30mm– 32mm
 Body Angle / Cuerpo Angulo: 25°

JET65											
Nozzle diameter Diamètre de la bluse Diámetro de la tobera Durchmesser der Hauptdüse Diametro ugello		Pressure Pression Presión Wasserdruck im Beregnere Pressione		Jet Length Portée Chorro Tragweite Gittata		Capacity Débit Capacidad Kapazität Portata			Values for a single sprinkler Données pour 1 arros. tout seul Datos para cada rociador Technische Daten für Einzelberegner Dati relativi ad 1 irrigatore		
									Irrigated area Surface arrosée Superficie irrigada Beregnete Fläche Superficie irrigata		Rainfall per hour Pluviométrie horaire Intensidad horaira Wassermenge pro Stund Intensità oraria
mm	inch	kg/cm ²	lbs/inch	m	feet	l/min	m ³ /h	G.P.M.	m ²	acre	mm/h
18	.70	3	44	32	105	390	23.4	103	3215	0.79	7.3
	.70	4	56	35	115	445	26.7	118	3847	0.95	6.9
	.70	5	70	38	125	498	29.9	132	4534	1.12	6.6
	.70	6	85	41	134	553	33.2	146	5278	1.30	6.3
20	0.78	3	44	35	115	500	30	132	3847	0.95	7.8
	0.78	4	56	39	128	583	35	154	4776	1.18	7.3
	0.78	5	70	43	141	650	39	172	5806	1.43	6.7
22	0.86	3	44	37	121	600	36	159	4299	1.06	8.4
	0.86	4	56	41	134	683	41	181	5278	1.30	7.8
	0.86	5	70	47	154	767	46	203	6936	1.71	6.6
	0.86	6	85	48	157	833	50	220	7234.56	1.79	6.9
24	0.94	4	44	43	141	730	48	211	5806	1.43	8.3
	0.94	5	56	49	161	917	55	242	7539	1.86	7.3
	0.94	6	70	52	171	983	59	260	8491	2.10	6.9
26	1.02	4	56	48	157	933	56	247	7235	1.79	7.7
	1.02	5	70	50	164	1050	63	277	7850	1.94	8.0
	1.02	6	85	53	174	1133	68	299	8820	2.18	7.7
28	1.1	4	56	49	161	1083	65	286	7539	1.86	8.6
	1.1	5	70	53	174	1200	72	317	8820	2.18	8.2
	1.1	6	85	56	184	1300	78	343	9847	2.43	7.9
30	1.18	5	70	55	180	1350	81	357	9499	2.35	8.5
	1.18	6	85	57	187	1483	89	392	10202	2.52	8.7
	1.18	7	100	61	200	1600	96	423	11684	2.89	8.2
32	1.25	5	70	56	184	1533	92	405	9847	2.43	9.3
	1.25	6	85	60	197	1667	100	440	11304	2.79	8.8
	1.25	7	100	63	207	1800	108	476	12463	3.08	8.7

The technical tables was created in zero wind conditions. The test tripod height is 1.2 Meters / Se crearon tablas técnicas en condiciones de viento cero. La altura del trípode de prueba es de 1,2 metros.

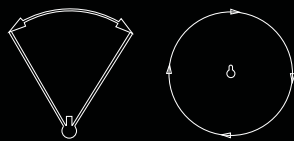

Part circle and Full circle

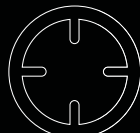

Barrel cross section

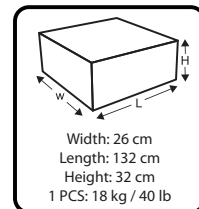

JET 70

Water Input / El agua de entrada: Flange 145mm x 78 mm"
 Working Pressure / Presión de trabajo: 4 – 9 kg/cm²
 Water Requirement / Requerimientos de agua: 63 m³/h – 122 m³/h
 Nozzles / Boquilla: 28mm – 30mm – 32mm – 34mm
 Body Angle / Cuerpo Ángulo: 23°

Yuzuak JET70 - Standart Nozzles

Nozzle diameter / Diamètre de la bluse / Diámetro de la tobera / Durchmesser der Hauptdüse / Diametro ugello		Pressure / Pression / Presiòn / Wasserdruck im Beregner / Pressione		Jet Length / Portée / Chorro / Tragweite / Gittata		Capacity / Débit / Capacidad / Kapazität / Portata			Values for a single sprinkler / Données pour 1 arros. tout seul / Datos para cada rociador / Technische Daten für Einzelberegner / Dati relativi ad 1 irrigatore		
									Irrigated area / Surface arrosée / Superficie irrigada / Beregnete / Fläche / Superficie irrigata		Rainfall per hour / Pluviométrie horaire / Intensidad horaira / Wassermenge pro Stund / Intensità oraria
mm	inch	kg/cm ²	lbs/inch	m	feet	l/min	m ³ /h	G.P.M.	m ²	acre	mm/h
28 Standart Nozzle	1.1	4	56	50	164	1050	63	277	7850	1.94	8.0
	1.1	5	70	54	177	1200	72	317	9156	2.26	7.9
	1.1	6	85	58	190	1300	78	343	10563	2.61	7.4
30 Standart Nozzle	1.18	4	56	52	171	1220	73.2	322	8491	2.10	8.6
	1.18	5	70	55	180	1383	83	365	9499	2.35	8.7
	1.18	6	85	60	197	1488	89.3	393	11304	2.79	7.9
32 Standart Nozzle	1.25	4	56	54	177	1383	83	365	9156	2.26	9.1
	1.25	5	70	58	190	1550	93	409	10563	2.61	8.8
	1.25	6	85	63	207	1733	104	458	12463	3.08	8.3
34 Standart Nozzle	1.25	7	100	66	216	1850	111	489	13678	3.38	8.1
	1.33	5	70	60	197	1750	105	462	11304	2.79	9.3
	1.33	6	85	64	210	1950	117	515	12861	3.18	9.1
	1.33	7	100	68	223	2033	122	537	14519	3.59	8.4

This model has speed adjustment. For Maximum Radius, the turning speed should be at a minimum.

Yuzuak JET70 - Optionally Nozzles

36 Standart Nozzle	1.42	6	85	65	213	2117	127	559	13267	3.28	9.6
	1.42	7	100	71	233	2253	135.2	595	15829	3.91	8.5
	1.42	8	114	74	243	2435	146.1	643	17195	4.25	8.5
38 Standart Nozzle	1.5	6	85	67	220	2317	139	612	14095	3.48	9.9
	1.5	7	100	72	236	2483	149	656	16278	4.02	9.2
	1.5	8	114	75	246	2683	161	709	17663	4.36	9.1
40 Standart Nozzle	1.57	6	85	68	223	2600	156	687	14519	3.59	10.7
	1.57	7	100	73	239	2700	162	713	16733	4.13	9.7
	1.57	8	114	76	249	2950	177	779	18137	4.48	9.8
42 Standart Nozzle	1.65	6	85	70	230	2800	168	740	15386	3.80	10.9
	1.65	7	100	74	243	3000	180	793	17195	4.25	10.5
	1.65	8	114	80	262	3200	192	845	20096	4.96	9.6

This model has speed adjustment. For Maximum Radius, the turning speed should be at a minimum.

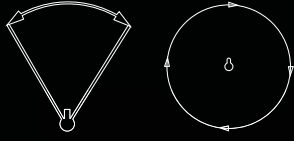

Part circle and Full circle

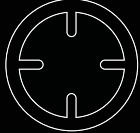

Barrel cross section

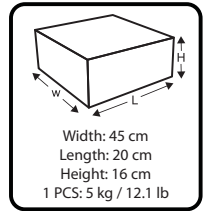

TURF JET

Water Input / El agua de entrada: 2"
 Working Pressure / Presión de trabajo: 2 – 6 kg/cm²
 Water Requirement / Requerimientos de agua: 6.5 m³/h – 48 m³/h
 Nozzles / Boquilla: 10mm – 12mm – 14mm – 16mm – 18mm – 20mm – 22mm
 Body Angle / Cuerpo Ángulo: 25°

TURFJET												
Nozzle diameter Diamètre de la bluse Diámetro de la tobera Durchmesser der Hauptdüse Diametro ugello		Pressure Pression Presión Wasserdruck im Beregner Pressione		Jet Length Portée Chorro Tragweite Gittata		Capacity Débit Capacidad Kapazität Portata			Values for a single sprinkler Données pour 1 arros. tout seul Datos para cada rociador Technische Daten für Einzelberegner Dati relativi ad 1 irrigatore			
									Irrigated area Surface arrosée Superficie irrigada Beregnete Fläche Superficie irrigata		Rainfall per hour Pluviométrie horaire Intensidad horaira Wassermenge pro Stund Intensità oraria	
mm	inch	kg/cm ²	lbs/inch	m	feet	l/min	m ³ /h	G.P.M.	m ²	acre	mm/h	
10	.39	2	29	19	62	108	6.5	29	1134	0.28	5.7	
	.39	3	44	21	69	125	7.5	33	1385	0.34	5.4	
	.39	4	56	23	75	143	8.6	38	1661	0.41	5.2	
12	.47	2	29	21	69	140	8.4	37	1385	0.34	6.1	
	.47	3	44	25	82	165	9.9	44	1963	0.48	5.0	
	.47	4	56	28	92	192	11.5	51	2462	0.61	4.7	
14	.55	3	56	28	92	238	14.3	63	2462	0.61	5.8	
	.55	4	70	30	98	283	17	75	2826	0.70	6.0	
	.55	5	85	32	105	303	18.2	80	3215	0.79	5.7	
16	.62	3	56	30	98	303	18.2	80	2826	0.70	6.4	
	.62	4	70	33	108	352	21.1	93	3419	0.84	6.2	
	.62	5	85	35	115	392	23.5	103	3847	0.95	6.1	
18	.70	3	85	31	102	367	22	97	3018	0.75	7.3	
	.70	4	85	34	112	438	26.3	116	3630	0.90	7.2	
	.70	5	85	37	121	492	29.5	130	4299	1.06	6.9	
	.70	6	85	38	125	537	32.2	142	4534	1.12	7.1	
20	.78	3	85	34	112	450	27	119	3630	0.90	7.4	
	.78	4	85	37	121	525	31.5	139	4299	1.06	7.3	
	.78	5	85	40	131	600	36	159	5024	1.24	7.2	
22	.86	4	85	37	121	633	38	167	4299	1.06	8.8	
	.86	5	85	40	131	700	42	185	5024	1.24	8.4	
	.86	6	85	43	141	733	44	194	5806	1.43	7.6	
	.86	7	100	46	151	808	48.5	214	6644	1.64	7.3	

The technical tables was created in zero wind conditions. The test tripod height is 1.2 Meters / Se crearon tablas técnicas en condiciones de viento cero. La altura del trípode de prueba es de 1,2 metros.

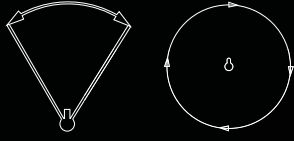

Part circle and Full circle

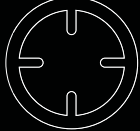

Barrel cross section



SUPER TURF JET

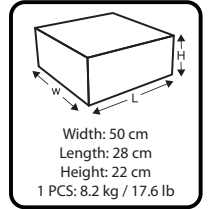

Water Input / El agua de entrada: 2"
 Working Pressure / Presión de trabajo: 3 – 7 kg/cm²
 Water Requirement / Requerimientos de agua: 23 m³/h – 108 m³/h
 Nozzles / Boquilla: 18mm – 20mm – 22mm – 24mm – 26mm – 28mm – 30mm – 32mm
 Body Angle / Cuerpo Ángulo: 25°

Super Turfjet											
Nozzle diameter Diamètre de la bluse Diámetro de la tobera Durchmesser der Hauptdüse Diametro ugello		Pressure Pression Presión Wasserdruck im Beregner Pressione		Jet Length Portée Chorro Tragweite Gittata		Capacity Débit Capacidad Kapazität Portata			Values for a single sprinkler Données pour 1 arros. tout seul Datos para cada rociador Technische Daten für Einzelberegner Dati relativi ad 1 irrigatore		
									Irrigated area Surface arrosée Superficie irrigada Beregnete Fläche Superficie irrigata		Rainfall per hour Pluviométrie horaire Intensidad horaira Wassermenge pro Stund Intensità oraria
mm	inch	kg/cm ²	lbs/inch	m	feet	l/min	m ³ /h	G.P.M.	m ²	acre	mm/h
18	.70	3	44	32	105	390	23.4	103	3215	0.79	7.3
	.70	4	56	35	115	445	26.7	118	3847	0.95	6.9
	.70	5	70	38	125	498	29.9	132	4534	1.12	6.6
	.70	6	85	41	134	553	33.2	146	5278	1.30	6.3
20	0.78	3	44	34	112	500	30	132	3630	0.90	8.3
	0.78	4	56	38	125	583	35	154	4534	1.12	7.7
	0.78	5	70	41	134	650	39	172	5278	1.30	7.4
22	0.86	3	44	36	118	600	36	159	4069	1.01	8.8
	0.86	4	56	40	131	683	41	181	5024	1.24	8.2
	0.86	5	70	45	148	767	46	203	6359	1.57	7.2
	0.86	6	85	47	154	833	50	220	6936.26	1.71	7.2
24	0.94	4	44	41	134	730	48	211	5278	1.30	9.1
	0.94	5	56	48	157	917	55	242	7235	1.79	7.6
	0.94	6	70	50	164	983	59	260	7850	1.94	7.5
26	1.02	4	56	46	151	933	56	247	6644	1.64	8.4
	1.02	5	70	48	157	1050	63	277	7235	1.79	8.7
	1.02	6	85	51	167	1133	68	299	8167	2.02	8.3
28	1.1	4	56	47	154	1083	65	286	6936	1.71	9.4
	1.1	5	70	51	167	1200	72	317	8167	2.02	8.8
	1.1	6	85	55	180	1300	78	343	9499	2.35	8.2
30	1.18	5	70	53	174	1350	81	357	8820	2.18	9.2
	1.18	6	85	54	177	1483	89	392	9156	2.26	9.7
	1.18	7	100	60	197	1600	96	423	11304	2.79	8.5
32	1.25	5	70	54	177	1533	92	405	9156	2.26	10.0
	1.25	6	85	58	190	1667	100	440	10563	2.61	9.5
	1.25	7	100	61	200	1800	108	476	11684	2.89	9.2

The technical tables was created in zero wind conditions. The test tripod height is 1.2 Meters / Se crearon tablas técnicas en condiciones de viento cero. La altura del trípode de prueba es de 1,2 metros.

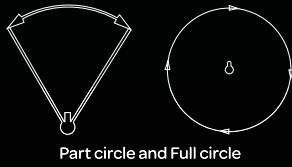

Part circle and Full circle

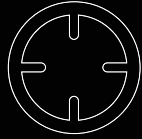

Barrel cross section

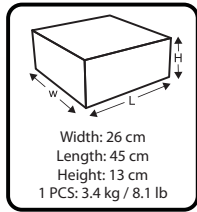

Width: 26 cm
Length: 45 cm
Height: 13 cm
1 PCS: 3.4 kg / 8.1 lb



Aluminium Nozzles



ATOM NGun

Water Input / El agua de entrada: 2" -1,5"
Working Pressure / Presión de trabajo: 1,75 – 4 kg/cm²
Water Requirement / Requerimientos de agua: 11 m³/h – 28 m³/h
Nozzles / Boquilla: 14mm – 15.2mm –16.5mm – 17.8mm – 19.1mm – 20.3mm
Body Angle / Cuerpo Ángulo: 18°

NGun - 3,7 M Riser , 18° Trajectory

Nozzle diameter Diamètre de la bluse / Diámetro de la tobera / Durchmesser der Hauptdüse / Diametro ugello		Pressure Pression / Presiòn / Wasserdruck im Beregner / Pressione		Jet Length Portée / Chorro / Tragweite / Gittata		Capacity Débit / Capacidad / Kapazität / Portata			Values for a single sprinkler Données pour 1 arros. tout seul / Datos para cada rociador / Technische Daten für Einzelberegner / Dati relativi ad 1 irrigatore		
									Irrigated area Surface arrosée / Superficie irrigada / Beregnete / Fläche Superficie irrigata		Rainfall per hour Pluviométrie horaire / Intensidad horaira / Wassermenge pro Stund / Intensità oraria
mm	inch	kg/cm ²	lbs/inch	m	feet	l/min	m ³ /h	G.P.M.	m ²	acre	mm/h
14mm	0.55	1.75	29	19.0	62	180	10.8	48	1134	0.28	9.5
	0.55	2	29	21.0	69	195	11.7	52	1385	0.34	8.4
	0.55	2.5	37	22.0	72	232	13.9	61	1520	0.38	9.1
	0.55	3	44	24.5	80	238	14.3	63	1885	0.47	7.6
15,2mm	0.60	2	29	23.0	75	195	11.7	52	1661	0.41	7.0
	0.60	2.5	37	24.0	79	217	13.0	57	1809	0.45	7.2
	0.60	3	44	26.0	85	238	14.3	63	2123	0.52	6.7
	0.60	4	56	27.0	89	277	16.6	73	2289	0.57	7.3
16,5mm	0.65	2	29	23.5	77	247	14.8	65	1734	0.43	8.5
	0.65	2.5	37	24.5	80	275	16.5	73	1885	0.47	8.8
	0.65	3	44	25.5	84	303	18.2	80	2042	0.50	8.9
	0.65	4	56	28.0	92	350	21.0	92	2462	0.61	8.5
17,8mm	0.70	2	29	24.0	79	308	18.5	81	1809	0.45	10.2
	0.70	2.5	37	25.5	84	333	20.0	88	2042	0.50	9.8
	0.70	3	44	26.0	85	343	20.6	91	2123	0.52	9.7
	0.70	4	56	29.0	95	437	26.2	115	2641	0.65	9.9
19,1mm	0.75	2	29	25.0	82	345	20.7	91	1963	0.48	10.5
	0.75	2.5	37	26.0	85	275	16.5	73	2123	0.52	7.8
	0.75	3	44	26.5	87	378	22.7	100	2205	0.54	10.3
	0.75	4	56	30.0	98	437	26.2	115	2826	0.70	9.3
20,3mm	0.80	2.5	37	27.0	89	375	22.5	99	2289	0.57	9.8
	0.80	3	44	28.0	92	375	22.5	99	2462	0.61	9.1
	0.80	4	56	32.0	105	460	27.6	122	3215	0.79	8.6

The technical tables was created in zero wind conditions. The test tripod height is 1.2 Meters / Se crearon tablas técnicas en condiciones de viento cero. La altura del trípode de prueba es de 1,2 metros.

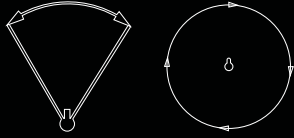

Part circle and Full circle

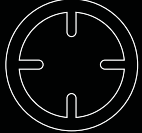

Barrel cross section

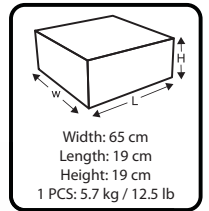

PIVOT JET

Water Input / El agua de entrada: 2" - 1,5"
 Working Pressure / Presión de trabajo: 1.75 - 5 kg/cm²
 Water Requirement / Requerimientos de agua: 7 m³/h - 28 m³/h
 Nozzles / Boquilla: 12mm - 14mm - 16mm - 18mm
 Body Angle / Cuerpo Ángulo: 18°

PIVOTJET Endgun - 3,7 M Riser , 18° Trajectory

Nozzle diameter Diamètre de la bluse Diámetro de la tobera Durchmesser der Hauptdüse Diametro ugello		Pressure Pression Presión Wasserdruck im Beregner Pressione		Jet Length Portée Chorro Tragweite Gittata		Capacity Débit Capacidad Kapazität Portata			Values for a single sprinkler Données pour 1 arros. tout seul Datos para cada rociador Technische Daten für Einzelberegner Dati relativi ad 1 irrigatore		
									Irrigated area Surface arrosée Superficie irrigada Beregnete Fläche Superficie irrigata		Rainfall per hour Pluviométrie horaire Intensidad horaira Wassermenge pro Stund Intensità oraria
mm	inch	kg/cm ²	lbs/inch	m	feet	l/min	m ³ /h	G.P.M.	m ²	acre	mm/h
12mm	.47	1.75	25	17	54	117	7	31	907	0.21	8.2
	.47	2	29	19	61	133	8	35	1133	0.27	7.4
	.47	2.5	37	20	66	162	9.7	43	1256	0.31	7.7
	.47	3	44	22	71	177	10.6	47	1451	0.36	7.3
	.47	4	56	24	77	203	12.2	54	1734	0.43	7.0
14mm	.55	1.75	25	18	59	168	10.1	44	1017	0.25	9.9
	.55	2	29	20	66	192	11.5	51	1256	0.31	9.2
	.55	2.5	37	22	71	220	13.2	58	1451	0.36	9.1
	.55	3	44	24	77	233	14	62	1734	0.43	8.1
	.55	4	56	26	85	270	16.2	71	2123	0.52	7.6
16mm	.62	2	29	23	75	242	14.5	64	1661	0.41	8.7
	.62	2.5	37	25	82	267	16	70	1963	0.48	8.2
	.62	3	44	26	85	297	17.8	78	2123	0.52	8.4
	.62	4	56	28	90	342	20.5	90	2375	0.59	8.6
	.62	5	70	30	98	445	26.7	118	2826	0.70	9.4
18mm	.70	2.5	37	25	82	350	21	92	1963	0.48	10.7
	.70	3	44	28	92	375	22.5	99	2462	0.61	9.1
	.70	4	56	29	95	438	26.3	116	2641	0.65	10.0
	.70	5	70	32	105	470	28.2	124	3215	0.79	8.8
	.70	5	70	35	115	717	43	189	3847	0.95	11.2
20mm	.78	3	44	30	98	445	26.7	118	2826	0.70	9.4
	.78	4	56	32	105	537	32.2	142	3215	0.79	10.0
	.78	5	70	34	112	592	35.5	156	3630	0.90	9.8
22mm	.86	3	44	30	98	557	33.4	147	2826	0.70	11.8
	.86	4	56	32	103	642	38.5	170	3116	0.77	12.4
	.86	5	70	35	115	717	43	189	3847	0.95	11.2

The technical tables was created in zero wind conditions. The test tripod height is 1.2 Meters / Se crearon tablas técnicas en condiciones de viento cero. La altura del trípode de prueba es de 1,2 metros.

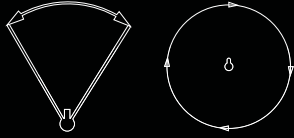

Part circle and Full circle

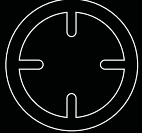

Barrel cross section

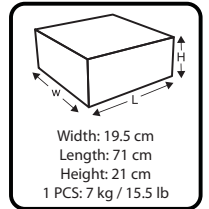

JET 35T

Water Input / El agua de entrada: 2"
 Working Pressure / Presión de trabajo: 2,5 – 6 kg/cm²
 Water Requirement / Requerimientos de agua: 10 m³/h – 32 m³/h
 Nozzles / Boquilla: 12mm – 14mm – 16mm – 18mm – 20mm – 22mm
 Body Angle / Cuerpo Ángulo: 25°

JET35T												
Nozzle diameter Diamètre de la bluse Diámetro de la tobera Durchmesser der Hauptdüse Diametro ugello		Pressure Pression Presión Wasserdruck im Beregner Pressione		Jet Length Portée Chorro Tragweite Gittata		Capacity Débit Capacidad Kapazität Portata			Values for a single sprinkler Données pour 1 arros. tout seul Datos para cada rociador Technische Daten für Einzelberegner Dati relativi ad 1 irrigatore			
									Irrigated area Surface arrosée Superficie irrigada Beregnete Fläche Superficie irrigata		Rainfall per hour Pluviométrie horaire Intensidad horaira Wassermenge pro Stund Intensità oraria	
mm	inch	kg/cm ²	lbs/inch	m	feet	l/min	m ³ /h	G.P.M.	m ²	acre	mm/h	
12	.47	2.5	37	22	72	162	10	43	1520	0.38	6.4	
	.47	3	44	24	79	177	11	47	1809	0.45	5.9	
	.47	4	56	26	85	203	12	54	2123	0.52	5.7	
14	.55	2.5	37	24	79	220	13	58	1809	0.45	7.3	
	.55	3	44	26	85	233	14	62	2123	0.52	6.6	
	.55	4	56	29	95	270	16	71	2641	0.65	6.1	
	.55	5	70	32	105	305	18	81	3215	0.79	5.7	
16	.62	2	29	26	85	242	15	64	2123	0.52	6.8	
	.62	3	44	29	95	297	18	78	2641	0.65	6.7	
	.62	4	56	31	100	342	21	90	2921	0.72	7.0	
	.62	5	70	33	108	387	23	102	3419	0.84	6.8	
18	.70	4	56	35	115	450	27	119	3847	0.95	7.0	
	.70	5	70	36	118	477	29	126	4069	1.01	7.0	
	.70	6	85	38	125	527	32	139	4534	1.12	7.0	

The technical tables was created in zero wind conditions. The test tripod height is 1.2 Meters / Se crearon tablas técnicas en condiciones de viento cero. La altura del trípode de prueba es de 1,2 metros.

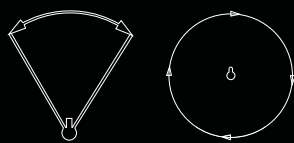

Part circle and Full circle

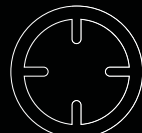

Barrel cross section

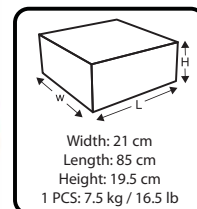

JET 50T

Water Input / El agua de entrada: 2 "
 Working Pressure / Presión de trabajo: 2 – 6 kg/cm²
 Water Requirement / Requerimientos de agua: 13 m³/h – 57 m³/h
 Nozzles / Boquilla: 14mm – 16mm – 18mm – 20mm – 22mm – 24mm
 Body Angle / Cuerpo Ángulo: 25°

JET50T												
Nozzle diameter Diamètre de la bluse Diámetro de la tobera Durchmesser der Hauptdüse Diametro ugello		Pressure Pression Presi òn Wasserdruck im Beregner Pressione		Jet Length Portée Chorro Tragweite Gittata		Capacity Débit Capacidad Kapazität Portata			Values for a single sprinkler Données pour 1 arros. tout seul			
									Datos para cada rociador		Technische Daten für Einzelberegner	
									Irrigated area Surface arrosée Superficie irrigada Beregnete Fläche Superficie irrigata		Rainfall per hour Pluviométrie horaire Intensidad horaira Wassermenge pro Stund Intensità oraria	
mm	inch	kg/cm ²	lbs/inch	m	feet	l/min	m ³ /h	G.P.M.	m ²	acre	mm/h	
14mm	.55	2.5	37	24	79	220	13.2	58	1809	0.45	7.3	
	.55	3	44	26	85	233	14	62	2123	0.52	6.6	
	.55	4	56	29	95	270	16.2	71	2641	0.65	6.1	
16mm	.62	2	29	26	85	242	14.5	64	2123	0.52	6.8	
	.62	3	44	29	95	297	17.8	78	2641	0.65	6.7	
	.62	4	56	30.5	100	342	20.5	90	2921	0.72	7.0	
18mm	.62	5	70	33	108	387	23.2	102	3419	0.84	6.8	
	.70	3	44	32	105	375	22.5	99	3215	0.79	7.0	
	.70	4	56	35	115	438	26.3	116	3847	0.95	6.8	
20mm	.70	5	70	37	121	470	28.2	124	4299	1.06	6.6	
	.70	6	85	40	131	522	31.3	138	5024	1.24	6.2	
	.78	3	44	35	115	445	26.7	118	3847	0.95	6.9	
22mm	.78	4	56	37	121	537	32.2	142	4299	1.06	7.5	
	.78	5	70	42	138	592	35.5	156	5539	1.37	6.4	
	.86	3	44	35	115	557	33.4	147	3847	0.95	8.7	
24mm	.86	4	56	37	121	642	38.5	170	4299	1.06	9.0	
	.86	5	70	40	131	717	43	189	5024	1.24	8.6	
	.86	6	85	42	138	787	47.2	208	5539	1.37	8.5	
24mm	.94	4	56	43	141	772	46.3	204	5806	1.43	8.0	
	.94	5	70	45	148	802	48.1	212	6359	1.57	7.6	
	.94	6	85	47	154	885	53.1	234	6936	1.71	7.7	

The technical tables was created in zero wind conditions. The test tripod height is 1.2 Meters / Se crearon tablas técnicas en condiciones de viento cero. La altura del trípode de prueba es de 1,2 metros.

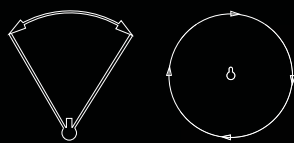

Part circle and Full circle

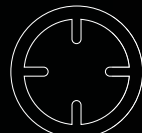

Barrel cross section

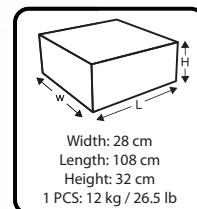

JET 65T

Water Input / El agua de entrada: Flange 130 mm x 78 mm "
 Working Pressure / Presión de trabajo: 3 – 7 kg/cm²
 Water Requirement / Requerimientos de agua: 22 m³/h – 82 m³/h
 Nozzles / Boquilla: 18mm – 20mm – 22mm – 24mm – 26mm – 28mm
 Body Angle / Cuerpo Ángulo: 24°

JET65T											
Nozzle diameter Diamètre de la bluse Diámetro de la tobera Durchmesser der Hauptdüse Diametro ugello		Pressure Pression Presión Wasserdruck im Beregner Pressione		Jet Length Portée Chorro Tragweite Gittata		Capacity Débit Capacidad Kapazität Portata			Values for a single sprinkler Données pour 1 arros. tout seul Datos para cada rociador Technische Daten für Einzelberegne Dati relativi ad 1 irrigatore		
									Irrigated area Surface arrosée Superficie irrigada Beregnete Fläche Superficie irrigata		Rainfall per hour Pluviométrie horaire Intensidad horaira Wassermenge pro Stund Intensità oraria
mm	inch	kg/cm ²	lbs/inch	m	feet	l/min	m ³ /h	G.P.M.	m ²	acre	mm/h
18mm	.70	3	44	32	105	375	22.5	99	3215	0.79	7.0
	.70	4	56	35	115	438	26.3	116	3847	0.95	6.8
	.70	5	70	37	121	470	28.2	124	4299	1.06	6.6
	.70	6	85	40	131	522	31.3	138	5024	1.24	6.2
20mm	.78	3	44	35	115	445	26.7	118	3847	0.95	6.9
	.78	4	56	37	121	537	32.2	142	4299	1.06	7.5
	.78	5	70	42	138	592	35.5	156	5539	1.37	6.4
22mm	.86	3	44	35	115	557	33.4	147	3847	0.95	8.7
	.86	4	56	37	121	642	38.5	170	4299	1.06	9.0
	.86	5	70	40	131	717	43	189	5024	1.24	8.6
	.86	6	85	42	138	787	47.2	208	5539	1.37	8.5
24mm	.94	4	56	43	141	772	46.3	204	5806	1.43	8.0
	.94	5	70	45	148	802	48.1	212	6359	1.57	7.6
	.94	6	85	47	154	885	53.1	234	6936	1.71	7.7
26mm	1	4	56	44	144	867	52	229	6079	1.50	8.6
	1	5	70	46	151	967	58	255	6644	1.64	8.7
	1	6	85	48	157	1067	64	282	7235	1.79	8.8
28mm	1.1	5	70	49	161	1117	67	295	7539	1.86	8.9
	1.1	6	85	51	167	1233	74	326	8167	2.02	9.1
	1.1	7	100	53	174	1358	82	359	8820	2.18	9.2

The technical tables was created in zero wind conditions. The test tripod height is 1.2 Meters / Se crearon tablas técnicas en condiciones de viento cero. La altura del trípode de prueba es de 1,2 metros.

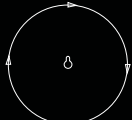

Full circle

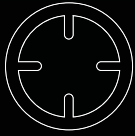

Barrel cross section

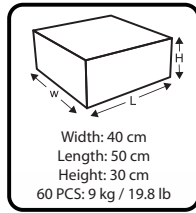

Main Nozzles

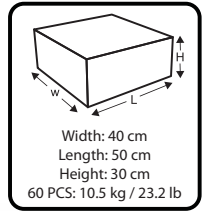

Back Nozzles



ATOM 14 WFC

Water Input / El agua de entrada: Flange 3/4 "
Working Pressure / Presión de trabajo: 2,0 – 3,5 kg/cm²
Water Requirement / Requerimientos de agua: 1,10 m³/h – 2,25 m³/h
Nozzles / Boquilla: 4mm – 4.5mm – 5mm
Body Angle / Cuerpo Ángulo: 25°



ATOM 14 WWB

ATOM 14 WFC - WWB

Nozzle diameter Diamètre de la bluse Diámetro de la tobera Durchmesser der Hauptdüse Diámetro ugello	Pressure Pression Presión Wasserdruck im Beregner Pressione		Jet Length Portée Chorro Tragweite Gittata		Capacity Débit Capacidad Kapazität Portata			Values for a single sprinkler Données pour 1 arros. tout seul Datos para cada rociador Technische Daten für Einzelberegner Dati relativi ad 1 irrigatore		
	kg/cm ²	lbs/inch	m	feet	l/min	m ³ /h	G.P.M.	Irrigated area Surface arrosée Superficie irrigada Beregnete Fläche Superficie irrigata	acre	Rainfall per hour Pluviométrie horaire Intensidad horaria Wassermenge pro Stund Intensità oraria
mm	kg/cm ²	lbs/inch	m	feet	l/min	m ³ /h	G.P.M.	m ²	acre	mm/h
4mm (Drive Nozzle) x 2,5mm	2	29	12	39,4	18,3	1,1	4,8	452	0,11	2,4
	2,5	36	12,5	41,0	22,5	1,35	5,9	491	0,12	2,8
	3	43	13	42,6	24,2	1,45	6,4	531	0,13	2,7
	3,5	50	13,5	44,3	26,7	1,6	7,0	572	0,14	2,8
4,5mm (Drive Nozzle) x 2,5mm	2	29	12,5	41,0	25,8	1,55	6,8	491	0,12	3,2
	2,5	36	13	42,6	28,3	1,7	7,5	531	0,13	3,2
	3	43	13,5	44,3	30,3	1,82	8,0	572	0,14	3,2
	3,5	50	14	45,9	34,2	2,05	9,0	615	0,15	3,3
5mm (Drive Nozzle) x 2,5mm	2	29	13,5	44,3	29,2	1,75	7,7	572	0,14	3,1
	2,5	36	14	45,9	31,7	1,9	8,4	615	0,15	3,1
	3	43	14,5	47,6	35,0	2,1	9,2	660	0,16	3,2
	3,5	50	15	49,2	37,5	2,25	9,9	707	0,17	3,2

The technical tables was created in zero wind conditions. The test tripod height is 1.2 Meters / Se crearon tablas técnicas en condiciones de viento cero. La altura del trípode de prueba es de 1,2 metros.

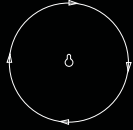

Full circle

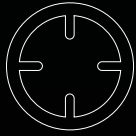

Barrel cross section

Back Nozzles



Green (Blind)



Turquoise (2.5 mm)



Black with Breaker (4 mm)

Main Nozzles



Black (4.5 mm)



Yellow (5 mm)



White (5.5 mm)

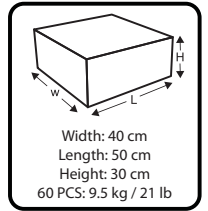

ATOM 14FC

Water Input / El agua de entrada: 3/4"
 Working Pressure / Presión de trabajo: 2,0 – 3,5 kg/cm²
 Water Requirement / Requerimientos de agua: 1,55 m³/h – 3,00 m³/h
 Nozzles / Boquilla: 4,5mm – 5mm – 5,5mm
 Body Angle / Cuerpo Ángulo: 25°

ATOM 14 FC												
Nozzle diameter Diamètre de la bluse Diámetro de la tobera Durchmesser der Hauptdüse Diametro ugello		Pressure Pression Presión Wasserdruck im Beregnen Pressione		Jet Length Portée Chorro Tragweite Gittata		Capacity Débit Capacidad Kapazität Portata			Values for a single sprinkler Données			
									pour 1 arros. tout seul Datos para cada rociador Technische Daten für Einzelberegner Dati relativi ad 1 irrigatore			
									Irrigated Area		Rainfall per hour	
mm	inch	kg/cm ²	lbs/inch	m	feet	l/min	m ³ /h	G.P.M.	m ²	acre	mm/h	
4,5mm x 2,5mm	11/64" x 3/32"	2.0	29	13.0	43	25.8	1.55	6.8	531	0.13	2.9	
		2.5	36	13.5	44	28.3	1.70	7.5	572	0.14	3.0	
		3.0	43	14.0	46	30.3	1.82	8.0	615	0.15	3.0	
		3.5	50	14.5	48	34.2	2.05	9.0	660	0.16	3.1	
5mm x 2,5mm	0.197" x 3/32"	2.0	29	14.0	46	29.2	1.75	7.7	615	0.15	2.8	
		2.5	36	14.5	48	31.7	1.90	8.4	660	0.16	2.9	
		3.0	43	15.0	49	35.0	2.10	9.2	707	0.17	3.0	
		3.5	50	15.5	51	37.5	2.25	9.9	754	0.19	3.0	
5mm x 4mm	0.197" x 5/32"	2.0	29	14.0	46	32.5	1.95	8.6	615	0.15	3.2	
		2.5	36	14.5	48	35.0	2.10	9.2	660	0.16	3.2	
		3.0	43	15.0	49	38.3	2.30	10.1	707	0.17	3.3	
		3.5	50	15.5	51	40.8	2.45	10.8	754	0.19	3.2	
5,5mm x 4mm	7/32" x 5/32"	2.0	29	14.0	46	39.2	2.35	10.3	615	0.15	3.8	
		2.5	36	15.0	49	42.5	2.55	11.2	707	0.17	3.6	
		3.0	43	15.5	51	47.5	2.85	12.5	754	0.19	3.8	
		3.5	50	16.0	52	50.0	3.00	13.2	804	0.20	3.7	

The technical tables was created in zero wind conditions. The test tripod height is 1.2 Meters / Se crearon tablas técnicas en condiciones de viento cero. La altura del trípode de prueba es de 1,2 metros.

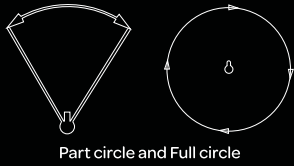

Part circle and Full circle

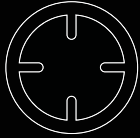

Barrel cross section

Main Nozzles



Red (4 mm) Black (4.5 mm) Yellow (5 mm)

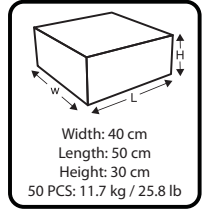

ATOM 14PC

Water Input / El agua de entrada: 3/4 "
 Working Pressure / Presión de trabajo: 2,0 – 3,5 kg/cm²
 Water Requirement / Requerimientos de agua: 0,9 m³/h – 1,80 m³/h
 Nozzles / Boquilla: 4mm – 4,5mm – 5mm
 Body Angle / Cuerpo Ángulo: 25°

ATOM 14 PC (one nozzle)											
Nozzle diameter Diamètre de la bluse Diámetro de la tobera Durchmesser der Hauptdüse Diametro ugello		Pressure Pression Presión Wasserdruck im Beregner Pressione		Jet Length Portée Chorro Tragweite Gittata		Capacity Débit Capacidad Kapazität Portata			Values for a single sprinkler Données pour 1 arros. tout seul Datos para cada rociador Technische Daten für Einzelberegne Dati relativi ad 1 irrigatore		
									Irrigated Area		Rainfall per hour
									Irrigated area Superficie irrigada Fläche Superficie irrigata	Surface arrosée Beregnete Superficie irrigata	Rainfall per hour horaire Intensidad horaira Wassermenge pro Stund Intensità oraria
mm	inch	kg/cm ²	lbs/inch	m	feet	l/min	m ³ /h	G.P.M.	m ²	acre	mm/h
4 mm (RED)	5/32" (RED)	2.0	29	12.0	39	15.3	0.92	4.1	452	0.11	2.0
		2.5	36	12.5	41	16.5	0.99	4.4	491	0.12	2.0
		3.0	43	13.0	43	18.3	1.10	4.8	531	0.13	2.1
		3.5	50	13.5	44	21.7	1.30	5.7	572	0.14	2.3
4,5 mm (BLACK)	11/64"(Black)	2.0	29	12.5	41	18.3	1.10	4.8	491	0.12	2.2
		2.5	36	13.0	43	20.3	1.22	5.4	531	0.13	2.3
		3.0	43	13.5	44	22.5	1.35	5.9	572	0.14	2.4
		3.5	50	14.0	46	24.2	1.45	6.4	615	0.15	2.4
5 mm (Yellow)	0.197"(Yellow)	2.0	29	13.5	44	23.3	1.40	6.2	572	0.14	2.4
		2.5	36	14.0	46	25.0	1.50	6.6	615	0.15	2.4
		3.0	43	14.5	48	27.5	1.65	7.3	660	0.16	2.5
		3.5	50	15.0	49	29.5	1.77	7.8	707	0.17	2.5

The technical tables was created in zero wind conditions. The test tripod height is 1.2 Meters / Se crearon tablas técnicas en condiciones de viento cero. La altura del trípode de prueba es de 1,2 metros.

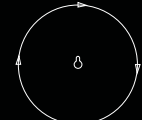

Full circle

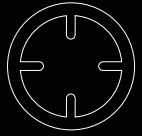

Barrel cross section

Main Nozzles



CIT* tested	Atom 15 FC	Δ 15x 15m
	CU in %	90
	DU in %	84

*Center of Irrigation Technologies
Fresno, California/USA

¹⁾ Nozzle size 6 x 3.2 mm 3 bar

Back Nozzles

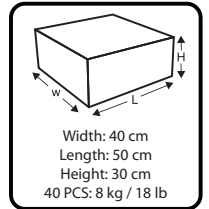
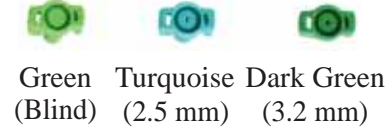

ATOM 15FC

Water Input / El agua de entrada: 1"
 Working Pressure / Presión de trabajo: 2 – 4,5 kg/cm²
 Water Requirement / Requerimientos de agua: 2 m³/h – 4,05 m³/h
 Nozzles / Boquilla: 5,5mm – 6mm – 6,5mm
 Body Angle / Cuerpo Ángulo: 22° - 27°



ATOM 15 FC												
Nozzle diameter Diámetro de la bluse Diámetro de la tobera Durchmesser der Hauptdüse Diametro ugello		Pressure Pression Presión Wasserdruck im Beregner Pressione		Jet Length Portée Chorro Tragweite Gittata		Capacity Débit Capacidad Kapazität Portata			Values for a single sprinkler Données pour 1 arros. tout seul Datos para cada rociador Technische Daten für Einzelberegne Dati relativi ad 1 irrigatore			
									Irrigated Area		Rainfall per hour	
									Irrigated area Surface arrosée Superficie irrigada Beregnete Fläche Superficie irrigata		Rainfall per hour Pluviométrie horaire Intensidad horaira Wassermenge pro Stund Intensità oraria	
mm	inch	kg/cm ²	lbs/inch	m	feet	l/min	m ³ /h	G.P.M.	m ²	acre	mm/h	
5mm x 3,2mm	0.197" x 1/8"	2.0	29	14.0	46	33.3	2.00	8.8	615	0.15	3.2	
		2.5	36	15.0	49	36.7	2.20	9.7	707	0.17	3.1	
		3.0	43	15.5	51	39.2	2.35	10.3	754	0.19	3.1	
		3.5	50	16.0	52	44.2	2.65	11.7	804	0.20	3.3	
		4.5	64	16.5	54	49.2	2.95	13.0	855	0.21	3.5	
5,5mm x 3,2mm	7/32" x 1/8"	2.0	29	14.5	48	37.5	2.25	9.9	660	0.16	3.4	
		2.5	36	15.5	51	40.8	2.45	10.8	754	0.19	3.2	
		3.0	43	16.0	52	45.8	2.75	12.1	804	0.20	3.4	
		3.5	50	16.5	54	48.3	2.90	12.8	855	0.21	3.4	
		4.5	64	17.4	57	54.2	3.25	14.3	951	0.23	3.4	
6mm X 3,2mm	15/64" x 1/8"	2.0	29	15.0	49	40.0	2.40	10.6	707	0.17	3.4	
		2.5	36	16.0	52	44.2	2.65	11.7	804	0.20	3.3	
		3.0	43	16.5	54	48.3	2.90	12.8	855	0.21	3.4	
		3.5	50	17.0	56	54.2	3.25	14.3	907	0.22	3.6	
		4.5	64	18.0	59	60.8	3.65	16.1	1017	0.25	3.6	
6,5mm X 3,2mm	1/4" x 1/8"	2.0	29	15.5	51	45.8	2.75	12.1	754	0.19	3.6	
		2.5	36	16.5	54	50.8	3.05	13.4	855	0.21	3.6	
		3.0	43	16.7	55	54.2	3.25	14.3	876	0.22	3.7	
		3.5	50	17.2	56	59.2	3.55	15.6	929	0.23	3.8	
		4.5	64	18.1	59	67.5	4.05	17.8	1029	0.25	3.9	

The technical tables was created in zero wind conditions. The test tripod height is 1.2 Meters / Se crearon tablas técnicas en condiciones de viento cero. La altura del trípode de prueba es de 1,2 metros.

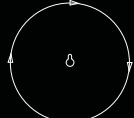

Full circle

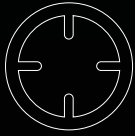

Barrel cross section

Main Nozzles



Red
(4 mm)



Black
(4.5 mm)



Yellow
(5 mm)

CIT* tested <small>*Center of Irrigation Technologies Fresno, California/USA</small>	Atom 15 LF	Δ 12 x 12m
	CU in %	89
	DU in %	88

¹⁾Nozzle Size 4,5 x 2,5 mm 2,5 bar

Back Nozzles



Green (Blind) (2.5 mm) Turquoise (3.2 mm) Dark Green (3.2 mm)

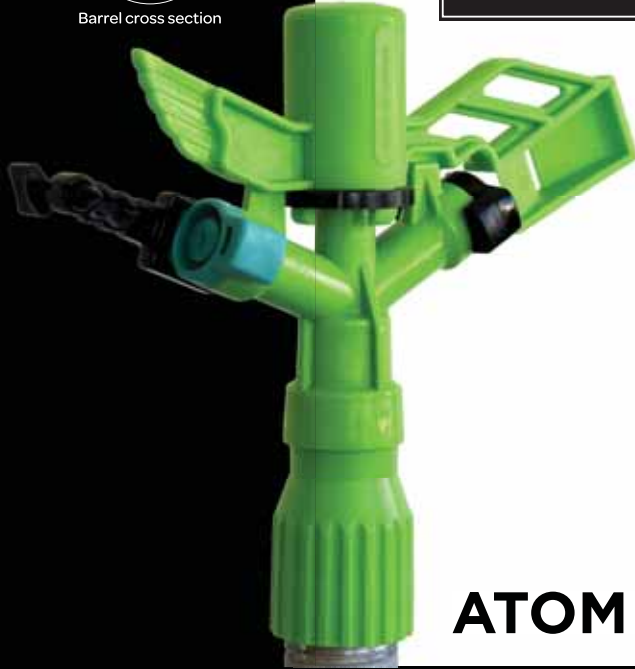
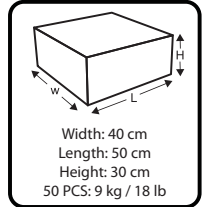

ATOM 15LF

Water Input / El agua de entrada: 1" Working Pressure / Presión de trabajo: 2 – 4,5 kg/cm²
 Water Requirement / Requerimientos de agua: 2 m³/h – 2,55 m³/h
 Nozzles / Boquilla: 4mm – 4,5mm – 5mm
 Body Angle / Cuerpo Ángulo: 22° - 27°

ATOM 15 LF													
Nozzle diameter Diamètre de la bluse Diámetro de la tobera Durchmesser der Hauptdüse Diametro ugello									Values for a single sprinkler			Données	
									pour 1 arros. tout seul			Datos para cada rociador	
Pressure Pression Presiòn Wasserdruck im Beregner Pressione									Technische Daten für Einzelberegner			Dati relativi ad 1 irrigatore	
									Irrigated Area			Rainfall per hour	
Jet Length Portée Chorro Tragweite Gittata									Irrigated area			Rainfall per hour	
									Surface arrosée			Pluviométrie horaire	
Capacity Débit Capacidad Kapazität Portata									Superficie irrigada			Intensidad horaira	
									Beregnete			Wassermenge pro	
mm									Fläche Superficie irrigata			Stund Intensità oraria	
									mm			mm/h	
inch									m ²			acre	
									m ²			acre	
kg/cm ²									l/min			mm/h	
									l/min			mm/h	
lbs/inch									m ³ /h			mm/h	
									m ³ /h			mm/h	
m									G.P.M.			mm/h	
									G.P.M.			mm/h	
4mm x 2,5mm	5.32" x 3/32"	2.0	29	13.0	43	18.3	1.10	4.8	531	0.13	2.1		
		2.5	36	13.5	44	22.5	1.35	5.9	572	0.14	2.4		
		3.0	43	14.2	47	24.2	1.45	6.4	633	0.16	2.3		
		3.5	50	14.6	48	27.5	1.65	7.3	669	0.17	2.5		
		4.5	64	15.0	49	30.3	1.82	8.0	707	0.17	2.6		
4,5mm x 2,5mm	11/64" x 3/32"	2.0	29	13.0	43	25.8	1.55	6.8	531	0.13	2.9		
		2.5	36	13.5	44	28.3	1.70	7.5	572	0.14	3.0		
		3.0	43	14.5	48	30.3	1.82	8.0	660	0.16	2.8		
		3.5	50	15.0	49	34.2	2.05	9.0	707	0.17	2.9		
		4.5	64	15.5	51	37.5	2.25	9.9	754	0.19	3.0		
5mm x 2,5mm	0.197" x 3/32"	2.0	29	14.0	46	29.2	1.75	7.7	615	0.15	2.8		
		2.5	36	15.0	49	32.5	1.95	8.6	707	0.17	2.8		
		3.0	43	15.5	51	35.8	2.15	9.5	754	0.19	2.9		
		3.5	50	16.0	52	38.3	2.30	10.1	804	0.20	2.9		
		4.5	64	16.5	54	42.5	2.55	11.2	855	0.21	3.0		

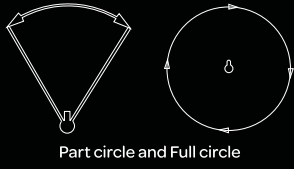

Part circle and Full circle

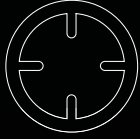

Barrel cross section

Main Nozzles

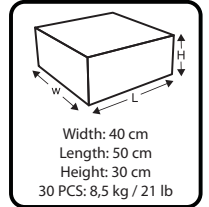

ATOM 15PC



Water Input / El agua de entrada: 1 "
 Working Pressure / Presión de trabajo: 2 – 4,5 kg/cm²
 Water Requirement / Requerimientos de agua: 1,3 m³/h – 3,3 m³/h
 Nozzles / Boquilla: 5mm – 5,5mm – 6mm – 6,5mm
 Body Angle / Cuerpo Ángulo: 23°

Atom15 PC												
Nozzle diameter Diamètre de la bluse Diámetro de la tobera Durchmesser der Hauptdüse Diametro ugello		Pressure Pression Presión Wasserdruck im Beregner Pressione		Jet Length Portée Chorro Tragweite Gittata		Capacity Débit Capacidad Kapazität Portata			Values for a single sprinkler Données pour 1 arros. tout seul Datos para cada rociador Technische Daten für Einzelberegne Dati relativi ad 1 irrigatore			
									Irrigated Area		Rainfall per hour	
									Irrigated area Surface arrosée Superficie irrigada Beregnete Fläche Superficie irrigata		Rainfall per hour Pluviométrie horaire Intensidad horaira Wassermenge pro Stund Intensità oraria	
mm	inch	kg/cm ²	lbs/inch	m	feet	l/min	m ³ /h	G.P.M.	m ²	acre	mm/h	
5 mm (Yellow)	0,197" (Yellow)	2.0	29	13.5	44	22.5	1.35	5.9	572	0.14	2.4	
		2.5	36	14.5	48	24.3	1.46	6.4	660	0.16	2.2	
		3.0	43	15.0	49	26.5	1.59	7.0	707	0.17	2.3	
		3.5	50	15.5	51	28.7	1.72	7.6	754	0.19	2.3	
5,5 mm (White)	7/32" (White)	2.0	29	14.5	48	26.3	1.58	7.0	660	0.16	2.4	
		2.5	36	15.5	51	29.3	1.76	7.7	754	0.19	2.3	
		3.0	43	16.0	52	32.2	1.93	8.5	804	0.20	2.4	
		3.5	50	16.0	52	34.7	2.08	9.2	804	0.20	2.6	
6 mm (Orange)	15/64" (Orange)	2.0	29	15.0	49	31.3	1.88	8.3	707	0.17	2.7	
		2.5	36	16.2	53	35.0	2.10	9.2	824	0.20	2.5	
		3.0	43	16.8	55	38.3	2.30	10.1	886	0.22	2.6	
		3.5	50	17.0	56	41.3	2.48	10.9	907	0.22	2.7	
6,5 mm (Blue)	1/4" (Blue)	2.0	29	15.4	51	36.7	2.20	9.7	745	0.18	3.0	
		2.5	36	16.5	54	41.0	2.46	10.8	855	0.21	2.9	
		3.0	43	17.3	57	45.0	2.70	11.9	940	0.23	2.9	
		3.5	50	17.5	57	48.5	2.91	12.8	962	0.24	3.0	

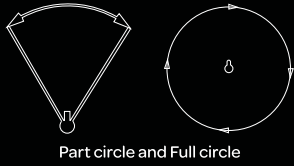

Part circle and Full circle



Barrel cross section

Main Nozzles



Red (4 mm) **Black** (4.5 mm) **Yellow** (5 mm)

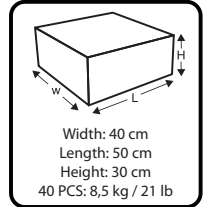

ATOM 15PC/LF

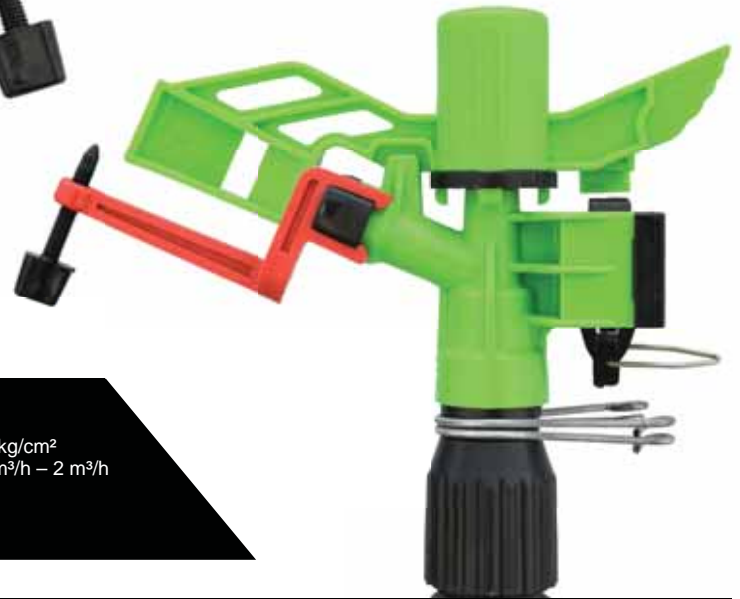

Water Input / El agua de entrada: 1 "
 Working Pressure / Presión de trabajo: 2 – 4,5 kg/cm²
 Water Requirement / Requerimientos de agua: 1,00 m³/h – 2 m³/h
 Nozzles / Boquilla: 4mm – 4,5mm – 5mm
 Body Angle / Cuerpo Ángulo: 23°

ATOM 15 PC LF												
Nozzle diameter Diamètre de la bluse Diámetro de la tobera Durchmesser der Hauptdüse Diametro ugello		Pressure Pression Presión Wasserdruck im Beregner Pressione		Jet Length Portée Chorro Tragweite Gittata		Capacity Débit Capacidad Kapazität Portata			Values for a single sprinkler Données pour 1 arros, tout seul Datos para cada rociador Technische Daten für Einzelberegner Dati relativi ad 1 irrigatore			
									Irrigated Area		Rainfall per hour	
									Irrigated area Surface arrosée Superficie irrigada Beregnete Fläche Superficie irrigata		Rainfall per hour Pluviométrie horaire Intensidad horaira Wassermenge pro Stund Intensità oraria	
mm	inch	kg/cm ²	lbs/inch	m	feet	l/min	m ³ /h	G.P.M.	m ²	acre	mm/h	
4 mm (RED)	5/32" (RED)	2.0	29	13.0	43	15.0	0.90	4.0	531	0.13	1.7	
		2.5	36	13.5	44	16.0	0.96	4.2	572	0.14	1.7	
		3.0	43	14.2	47	17.5	1.05	4.6	633	0.16	1.7	
		3.5	50	14.6	48	20.8	1.25	5.5	669	0.17	1.9	
4,5 mm (Black)	11/64" (Black)	2.0	29	13.0	43	17.5	1.05	4.6	531	0.13	2.0	
		2.5	36	13.5	44	19.7	1.18	5.2	572	0.14	2.1	
		3.0	43	14.5	48	21.5	1.29	5.7	660	0.16	2.0	
		3.5	50	15.0	49	23.3	1.40	6.2	707	0.17	2.0	
5 mm (Yellow)	0.197" (Yellow)	2.0	29	14.0	46	22.5	1.35	5.9	615	0.15	2.2	
		2.5	36	15.0	49	24.3	1.46	6.4	707	0.17	2.1	
		3.0	43	15.5	51	26.5	1.59	7.0	754	0.19	2.1	
		3.5	50	16.0	52	28.7	1.72	7.6	804	0.20	2.1	

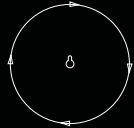

Full circle



Barrel cross section

Main Nozzles



Yellow
(5 mm)



White
(5.5 mm)



Orange
(6 mm)

Back Nozzles



Green
(Blind)



Turquoise
(2.5 mm)



Dark Green
(3.2 mm)

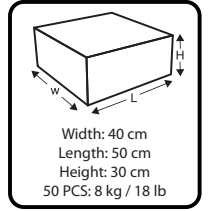

ATOM 15LA

Water Input / El agua de entrada: 1 "
 Working Pressure / Presión de trabajo: 2 – 2.45 kg/cm²
 Water Requirement / Requerimientos de agua: 1.75 m³/h – 3.25 m³/h
 Nozzles / Boquilla: 5mm – 5.5mm – 6mm
 Body Angle / Cuerpo Ángulo: 7°-10°

ATOM 15 LA 7° & 10°											
Nozzle diameter Diamètre de la bluse Diámetro de la tobera Durchmesser der Hauptdüse Diametro ugello		Pressure Pression Presión Wasserdruck im Beregner Pressione		Jet Length Portée Chorro Tragweite Gittata		Capacity Débit Capacidad Kapazität Portata			Values for a single sprinkler Données pour 1 arros. tout seul Datos para cada rociador Technische Daten für Einzelberegner Datì relativi ad 1 irrigatore		
									Irrigated area Surface arrosée Superficie irrigada Beregnete Fläche Superficie irrigata		Rainfall per hour Pluviométrie horaire Intensidad horaria Wassermenge pro Stund Intensità oraria
mm	inch	kg/cm ²	lbs/inch	m	feet	l/min	m ³ /h	G.P.M.	m ²	acre	mm/h
5,0 mm x 2,5mm	0.197" x 3/32"	2.0	29	9.2	30	29.2	1.75	7.7	268	0.07	6.5
		2.5	36	9.9	33	32.5	1.95	8.6	311	0.08	6.3
		3.0	43	10.5	35	35.8	2.15	9.5	348	0.09	6.2
		3.5	50	11.1	36	38.3	2.30	10.1	383	0.09	6.0
		4.5	64	12.0	39	42.5	2.55	11.2	449	0.11	5.7
5,5 mm x 2,5mm	7/32" x 3/32"	2.0	29	9.6	31	34.2	2.05	9.0	287	0.07	7.2
		2.5	36	10.2	33	36.7	2.20	9.7	327	0.08	6.7
		3.0	43	10.9	36	41.7	2.50	11.0	370	0.09	6.8
		3.5	50	11.4	37	44.2	2.65	11.7	406	0.10	6.5
		4.5	64	12.4	41	49.2	2.95	13.0	479	0.12	6.2
6,0 mm x 2,5mm	15/64" x 3/32"	2.0	29	9.8	32	35.8	2.15	9.5	298	0.07	7.2
		2.5	36	10.5	35	40.0	2.40	10.6	348	0.09	6.9
		3.0	43	11.1	36	44.2	2.65	11.7	388	0.10	6.8
		3.5	50	11.7	38	49.2	2.95	13.0	430	0.11	6.9
		4.5	64	12.7	42	54.2	3.25	14.3	504	0.12	6.4

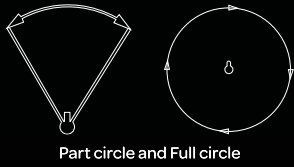

Part circle and Full circle

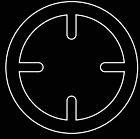

Barrel cross section

CIT* tested	Atom 22	15 x 20m
	CU in %	92
	DU in %	85

*Center of Irrigation Technologies
Fresno, California/USA

¹⁾Nozzle Size 6 mm 3 bar

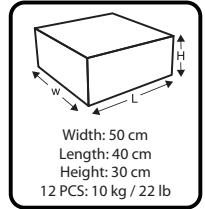

ATOM 22PC

Water Input / El agua de entrada: 1 "
 Working Pressure / Presión de trabajo: 1,5 – 4 kg/cm²
 Water Requirement / Requerimientos de agua: 2,4 m³/h – 8,6 m³/h
 Nozzles / Boquilla: 6mm – 8mm – 10mm
 Body Angle / Cuerpo Ángulo: 27°

Atom22											
Nozzle diameter Diamètre de la bluse Diámetro de la tobera Durchmesser der Hauptdüse Diametro ugello		Pressure Pression Presi òn Wasserdruck im Beregner Pressione		Jet Length Portée Chorro Tragweite Gittata		Capacity Débit Capacidad Kapazität Portata			Values for a single sprinkler Données pour 1 arros. tout seul		
									Irrigated area Surface arrosée Superficie irrigada Beregnete Fläche Superficie irrigata		Rainfall per hour Pluviométrie horaire Intensidad horaira assermenge pro Stund Intensità oraria
mm	inch	kg/cm ²	lbs/inch	m	feet	l/min	m ³ /h	G.P.M.	m ²	acre	mm/h
6mm X 4mm	0.24	1.5	22	13.0	43	40	2.4	11	531	0.13	4.5
	0.24	2	29	15.0	49	46	2.8	12	707	0.17	4.0
	0.24	3	44	17.0	56	56	3.4	15	907	0.22	3.7
	0.24	4	56	18.0	59	65	3.9	17	1017	0.25	3.8
8mm X 4mm	0.31	1.5	22	14.5	48	61	3.7	16	660	0.16	5.6
	0.31	2	29	16.5	54	71	4.3	19	855	0.21	5.0
	0.31	3	44	18.0	59	86	5.2	23	1017	0.25	5.1
	0.31	4	56	19.0	62	100	6.0	26	1134	0.28	5.3
10mm X 4mm	0.39	2	29	17.0	56	102	6.1	27	907	0.22	6.7
	0.39	3	44	19.5	64	124	7.4	33	1194	0.29	6.2
	0.39	4	56	21.0	69	144	8.6	38	1385	0.34	6.2

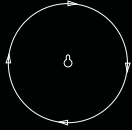

Full circle

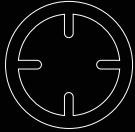

Barrel cross section

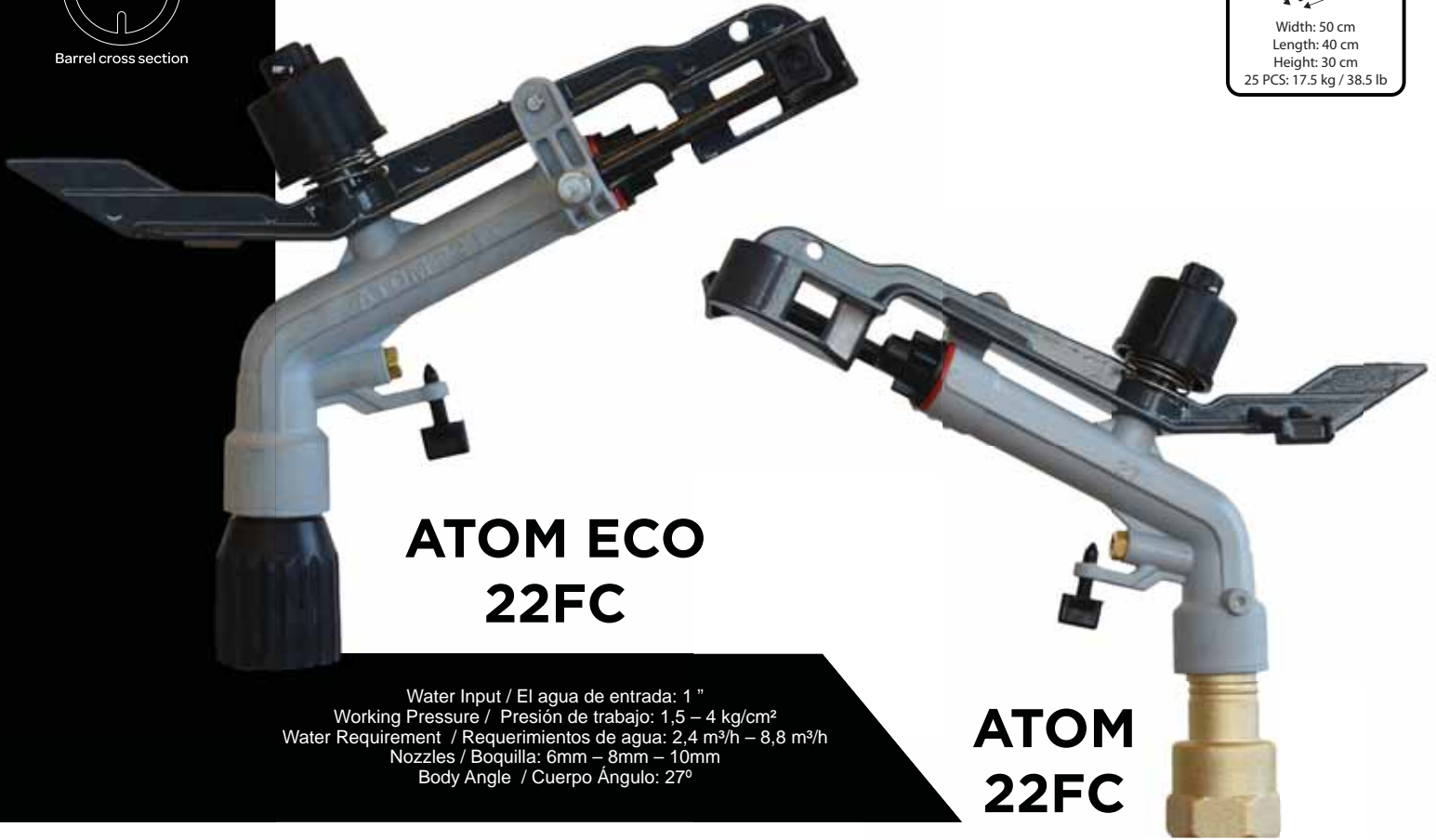
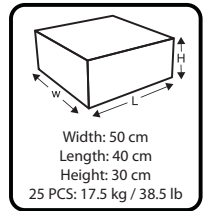
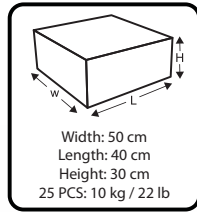

ATOM ECO 22FC

ATOM 22FC

Water Input / El agua de entrada: 1 "
Working Pressure / Presión de trabajo: 1,5 – 4 kg/cm²
Water Requirement / Requerimientos de agua: 2,4 m³/h – 8,8 m³/h
Nozzles / Boquilla: 6mm – 8mm – 10mm
Body Angle / Cuerpo Ángulo: 27°

Atom22												
Nozzle diameter Diamètre de la bluse Diámetro de la tobera Durchmesser der Hauptdüse Diametro ugello		Pressure Pression Presi òn Wasserdruck im Beregnner Pressione		Jet Length Portée Chorro Tragweite Gittata		Capacity Débit Capacidad Kapazität Portata			Values for a single sprinkler Données pour 1 arros. tout seul Datos para cada rociador Daten für Einzelberegne ad 1 irrigatore			
									Irrigated area Surface arrosée Superficie irrigada Beregnete Fläche Superficie irrigata		Rainfall per hour Pluviométrie horaire Intensidad horaira assermenge pro Stund Intensità oraria	
mm	inch	kg/cm ²	lbs/inch	m	feet	l/min	m ³ /h	G.P.M.	m ²	acre	mm/h	
6mm X 4mm	0.24	1.5	22	13.0	43	40	2.4	11	531	0.13	4.5	
	0.24	2	29	15.0	49	46	2.8	12	707	0.17	4.0	
	0.24	3	44	17.0	56	56	3.4	15	907	0.22	3.7	
	0.24	4	56	18.0	59	65	3.9	17	1017	0.25	3.8	
8mm X 4mm	0.31	1.5	22	14.5	48	61	3.7	16	660	0.16	5.6	
	0.31	2	29	16.5	54	71	4.3	19	855	0.21	5.0	
	0.31	3	44	18.0	59	86	5.2	23	1017	0.25	5.1	
	0.31	4	56	19.0	62	100	6.0	26	1134	0.28	5.3	
10mm X 4mm	0.39	2	29	17.0	56	102	6.1	27	907	0.22	6.7	
	0.39	3	44	19.5	64	124	7.4	33	1194	0.29	6.2	
	0.39	4	56	21.0	69	144	8.6	38	1385	0.34	6.2	

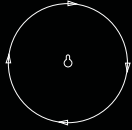

Full circle

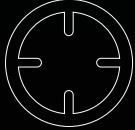

Barrel cross section

Main Nozzles



Turquoise (8 mm) Red (10 mm) Green (12 mm)

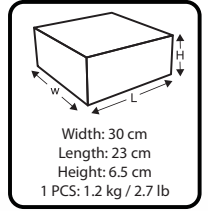

ATOM 30X FC

Water Input / El agua de entrada: 1,25 "
 Working Pressure / Presión de trabajo: 2 – 4 kg/cm²
 Water Requirement / Requerimientos de agua: 6 m³/h – 14,5 m³/h
 Nozzles / Boquilla: 8mm – 10mm – 12mm
 Body Angle / Cuerpo Ángulo: 27°

ATOM30 X FC											
Nozzle diameter Diamètre de la bluse Diámetro de la tobera Durchmesser der Hauptdüse Diametro ugello		Pressure Pression Presión Wasserdruck im Beregner Pressione		Jet Length Portée Chorro Tragweite Gittata		Capacity Débit Capacidad Kapazität Portata			Values for a single sprinkler Données pour 1 arros. tout seul Datos para cada rociador Technische Daten für Einzelberegner Dati relativi ad 1 irrigatore		
									Irrigated area Surface arrosée Superficie irrigada Beregnete Fläche Superficie irrigata		Rainfall per hour Pluviométrie horaire Intensidad horaria Wassermenge pro Stund Intensità oraria
mm	inch main nozzle	kg/cm ²	lbs/inch	m	feet	l/min	m ³ /h	G.P.M.	m ²	acre	mm/h
7 x 8 (main nozzle)	.31	2	30	16	52	100	6.00	26	804	0.20	7.5
	.31	3	45	18	59	117	7.00	31	1017	0.25	6.9
	.31	4	56	20	66	133	8.00	35	1256	0.31	6.4
7 X 10 (main nozzle)	.39	2	30	17	56	125	7.50	33	907	0.22	8.3
	.39	3	45	20	66	155	9.30	41	1256	0.31	7.4
	.39	4	56	21.5	71	180	10.80	48	1451	0.36	7.4
7 X 12 (main nozzle)	.47	2	30	18	59	163	9.80	43	1017	0.25	9.6
	.47	3	45	21	69	200	12.00	53	1385	0.34	8.7
	.47	4	56	24	79	237	14.20	63	1809	0.45	7.9

The technical tables was created in zero wind conditions. The test tripod height is 1.2 Meters / Se crearon tablas técnicas en condiciones de viento cero. La altura del trípode de prueba es de 1,2 metros.

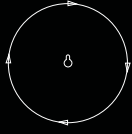

Full circle

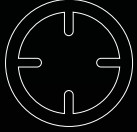

Barrel cross section

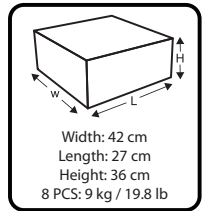
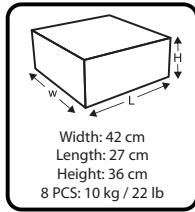

ATOM 30 FC

Water Input / El agua de entrada: 1,5"
 Working Pressure / Presión de trabajo: 2 – 5 kg/cm²
 Water Requirement / Requerimientos de agua: 6 m³/h – 18 m³/h
 Nozzles / Boquilla: 8mm – 10mm – 12mm – 14mm
 Body Angle / Cuerpo Ángulo: 27°

Main Nozzles

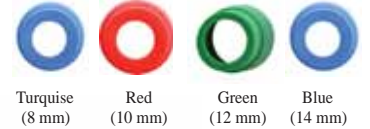

ATOM 30PC

ATOM30												
Nozzle diameter Diamètre de la bluse Diámetro de la tobera Durchmesser der Hauptdüse Diametro ugello		Pressure Pression Presión Wasserdruck im Beregner Pressione		Jet Length Portée Chorro Tragweite Gittata		Capacity Débit Capacidad Kapazität Portata			Values for a single sprinkler Données pour 1 arros. tout seul Datos para cada rociador Technische Daten für Einzelberegner Dati relativi ad 1 irrigatore			
									Irrigated area Surface arrosée Superficie irrigada Beregnete Fläche Superficie irrigata		Rainfall per hour Pluviométrie horaire Intensidad horaira Wassermenge pro Stund Intensità oraria	
mm	inch main nozzle	kg/cm ²	lbs/inch	m	feet	l/min	m ³ /h	G.P.M.	m ²	acre	mm/h	
7 x 8 (main nozzle)	.31	2	30	17	56	100	6.00	26	907	0.22	6.6	
	.31	3	45	19	62	117	7.00	31	1134	0.28	6.2	
	.31	4	56	21	69	133	8.00	35	1385	0.34	5.8	
7 X 10 (main nozzle)	.39	2	30	18	59	125	7.50	33	1017	0.25	7.4	
	.39	3	45	21	69	155	9.30	41	1385	0.34	6.7	
	.39	4	56	22.5	74	180	10.80	48	1590	0.39	6.8	
7 X 12 (main nozzle)	.47	2	30	19	62	163	9.80	43	1134	0.28	8.6	
	.47	3	45	22	72	200	12.00	53	1520	0.38	7.9	
	.47	4	56	25	82	237	14.20	63	1963	0.48	7.2	
7 X 14 (main nozzle)	.55	2	30	22	72	212	12.70	56	1520	0.38	8.4	
	.55	3	45	25	82	242	14.50	64	1963	0.48	7.4	
	.55	4	56	27	89	300	18.00	79	2289	0.57	7.9	
	.55	5	70	29	95	333	20.00	88	2641	0.65	7.6	

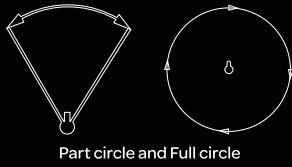

Part circle and Full circle

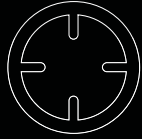

Barrel cross section

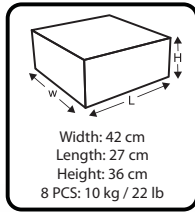

Main Nozzles

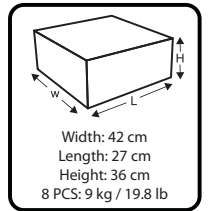

CIT* tested	Atom 28	25 x 21m
	CU in %	90
	DU in %	84

*Center of Irrigation Technologies
Fresno, California/USA

¹Nozzle size 12 mm 4 bar

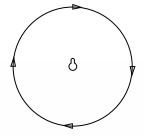

Full circle

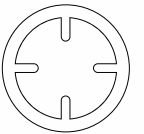

Barrel cross section



ATOM 28 ECO PC

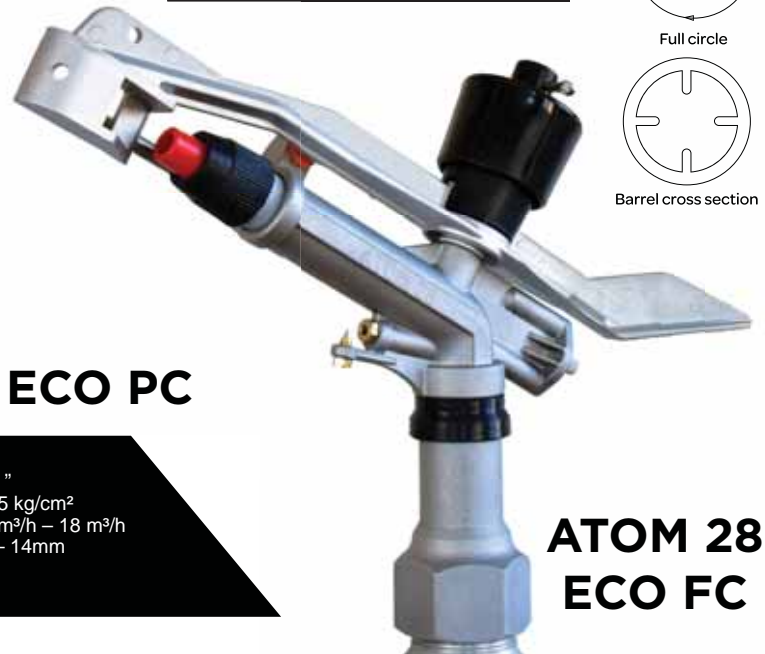

**ATOM 28
ECO FC**

Water Input / El agua de entrada: 1,5"
Working Pressure / Presión de trabajo: 2 – 5 kg/cm²
Water Requirement / Requerimientos de agua: 6 m³/h – 18 m³/h
Nozzles / Boquilla: 8mm – 10mm – 12mm – 14mm
Body Angle / Cuerpo Ángulo: 27°

Atom28												
Nozzle diameter Diamètre de la bluse Diámetro de la tobera Durchmesser der Hauptdüse Diametro ugello		Pressure Pression Presiòn Wasserdruck im Beregner Pressione		Jet Length Portée Chorro Tragweite Gittata		Capacity Débit Capacidad Kapazität Portata			Values for a single sprinkler Données pour 1 arros. tout seul Datos para cada rociador Technische Daten für Einzelberegner Dati relativi ad 1 irrigatore			
									Irrigated area Surface arrosée Superficie irrigada Beregnete Fläche Superficie irrigata		Rainfall per hour Pluviométrie horaire Intensidad horaira Wassermenge pro Stund Intensità oraria	
mm	inch	kg/cm ²	lbs/inch	m	feet	l/min	m ³ /h	G.P.M.	m ²	acre	mm/h	
10mm	.39	2.00	29	19	62	108.3	6.5	29	1134	0.28	5.7	
	.39	3.00	44	21	69	130	7.8	34	1385	0.34	5.6	
	.39	4.00	56	23	74	151.7	9.1	40	1590	0.39	5.7	
	.39	5.00	70	23.5	77	236	10.5	46	1734	0.43	6.1	
12mm	.47	2.00	29	21.0	69	152	9.0	40	1385	0.34	6.5	
	.47	3.00	44	23.0	75	182	11.2	49	1661	0.41	6.7	
	.47	4.00	56	25.0	82	211	13.0	57	1963	0.48	6.6	
	.47	5.00	70	26.5	87	236	14.2	63	2205	0.54	6.4	
14mm	.55	2.00	29	22.0	72	195	12.0	53	1520	0.38	7.9	
	.55	3.00	44	23.5	77	239	14.1	62	1734	0.43	8.1	
	.55	4.00	56	26.0	85	277	16.5	73	2123	0.52	7.8	
	.55	5.00	70	28.0	92	309	18.8	83	2462	0.61	7.6	

The technical tables was created in zero wind conditions. The test tripod height is 1.2 Meters / Se crearon tablas técnicas en condiciones de viento cero. La altura del trípode de prueba es de 1,2 metros.

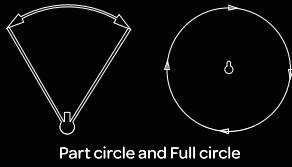

Part circle and Full circle

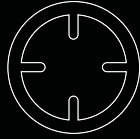

Barrel cross section

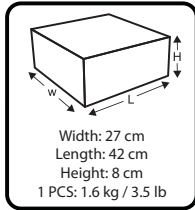

Main Nozzles

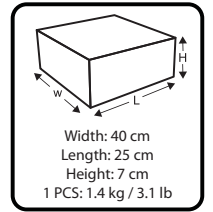

ATOM 28 X PC

Water Input / El agua de entrada: 1,25 "
Working Pressure / Presión de trabajo: 1,5 – 4 kg/cm²
Water Requirement / Requerimientos de agua: 6,5 m³/h – 16,5 m³/h
Nozzles / Boquilla: 10mm – 12mm – 14mm
Body Angle / Cuerpo Ángulo: 28°

CIT* tested

Atom 28	28 x 21m
CU in %	90
DU in %	84

*Center of Irrigation Technologies
Fresno, California/USA

¹⁾ Nozzle size 12 mm 4 bar

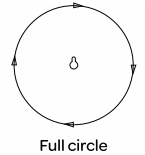

Full circle

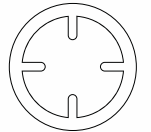

Barrel cross section

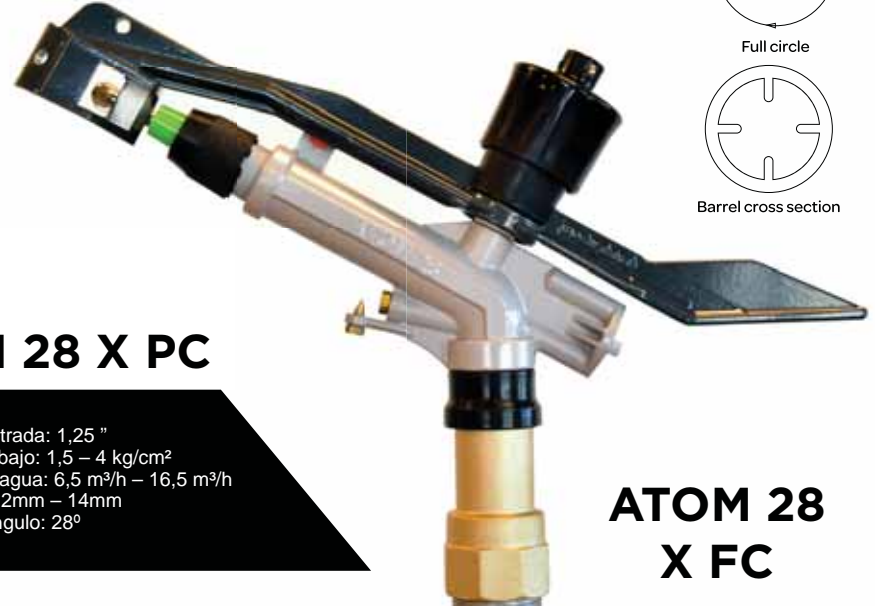

ATOM 28 X FC

Atom28												
Nozzle diameter Diamètre de la bluse Diámetro de la tobera Durchmesser der Hauptdüse Diametro ugello		Pressure Pression Presión Wasserdruck im Beregner Pressione		Jet Length Portée Chorro Tragweite Gittata		Capacity Débit Capacidad Kapazität Portata			Values for a single sprinkler Données pour 1 arros. tout seul Datos para cada rociador Technische Daten für Einzelberegner Dati relativi ad 1 irrigatore			
									Irrigated area Surface arrosée Superficie irrigada Beregnete Fläche Superficie irrigata		Rainfall per hour Pluviométrie horaire Intensidad horaira Wassermenge pro Stund Intensità oraria	
mm	inch	kg/cm ²	lbs/inch	m	feet	l/min	m ³ /h	G.P.M.	m ²	acre	mm/h	
10mm	.39	2.00	29	19	62	108.3	6.5	29	1134	0.28	5.7	
	.39	3.00	44	21	69	130	7.8	34	1385	0.34	5.6	
	.39	4.00	56	23	74	151.7	9.1	40	1590	0.39	5.7	
	.39	5.00	70	23.5	77	236	10.5	46	1734	0.43	6.1	
12mm	.47	2.00	29	21.0	69	152	9.0	40	1385	0.34	6.5	
	.47	3.00	44	23.0	75	182	11.2	49	1661	0.41	6.7	
	.47	4.00	56	25.0	82	211	13.0	57	1963	0.48	6.6	
	.47	5.00	70	26.5	87	236	14.2	63	2205	0.54	6.4	
14mm	.55	2.00	29	22.0	72	195	12.0	53	1520	0.38	7.9	
	.55	3.00	44	23.5	77	239	14.1	62	1734	0.43	8.1	
	.55	4.00	56	26.0	85	277	16.5	73	2123	0.52	7.8	
	.55	5.00	70	28.0	92	309	18.8	83	2462	0.61	7.6	

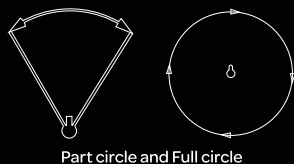

Part circle and Full circle

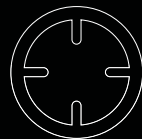

Barrel cross section

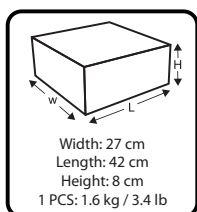

Main Nozzles



CIT* tested	Atom 28	25 x 21m
	CU in %	90
	DU in %	84

*Center of Irrigation Technologies
Fresno, California/USA

¹⁾Nozzle size 12 mm 4 bar

ATOM 28

Water Input / El agua de entrada: 1,5"
 Working Pressure / Presión de trabajo: 1,5 – 5 kg/cm²
 Water Requirement / Requerimientos de agua: 6,5 m³/h – 18,8 m³/h
 Nozzles / Boquilla: 10mm – 12mm – 14mm
 Body Angle / Cuerpo Ángulo: 28°

Atom28

Nozzle diameter Diamètre de la bluse Diámetro de la tobera Durchmesser der Hauptdüse Diametro ugello		Pressure Pression Presión Wasserdruck im Beregner Pressione		Jet Length Portée Chorro Tragweite Gittata		Capacity Débit Capacidad Kapazität Portata			Values for a single sprinkler Données pour 1 arros. tout seul Datos para cada rociador Technische Daten für Einzelberegner Dati relativi ad 1 irrigatore		
									Irrigated area Surface arrosée Superficie irrigada Beregnete Fläche Superficie irrigata		Rainfall per hour Pluviométrie horaire Intensidad horaira Wassermenge pro Stund Intensità oraria
mm	inch	kg/cm ²	lbs/inch	m	feet	l/min	m ³ /h	G.P.M.	m ²	acre	mm/h
10mm	.39	2.00	29	19	62	108.3	6.5	29	1134	0.28	5.7
	.39	3.00	44	21	69	130	7.8	34	1385	0.34	5.6
	.39	4.00	56	23	74	151.7	9.1	40	1590	0.39	5.7
	.39	5.00	70	23.5	77	236	10.5	46	1734	0.43	6.1
12mm	.47	2.00	29	21.0	69	152	9.0	40	1385	0.34	6.5
	.47	3.00	44	23.0	75	182	11.2	49	1661	0.41	6.7
	.47	4.00	56	25.0	82	211	13.0	57	1963	0.48	6.6
	.47	5.00	70	26.5	87	236	14.2	63	2205	0.54	6.4
14mm	.55	2.00	29	22.0	72	195	12.0	53	1520	0.38	7.9
	.55	3.00	44	23.5	77	239	14.1	62	1734	0.43	8.1
	.55	4.00	56	26.0	85	277	16.5	73	2123	0.52	7.8
	.55	5.00	70	28.0	92	309	18.8	83	2462	0.61	7.6

The technical tables was created in zero wind conditions. The test tripod height is 1.2 Meters / Se crearon tablas técnicas en condiciones de viento cero. La altura del trípode de prueba es de 1,2 metros.

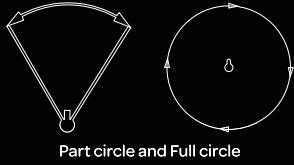

Part circle and Full circle

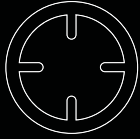

Barrel cross section

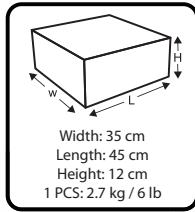

Width: 35 cm
Length: 45 cm
Height: 12 cm
1 PCS: 2.7 kg / 6 lb

CIT* tested	Atom 35	12 x 12m
	CU in %	91
	DU in %	85
*Center of Irrigation Technologies Fresno, California/USA		
1) Nozzle Size 14 x 5 mm 5 bar		



ATOM 35

Water Input / El agua de entrada: 1,5"
Working Pressure / Presión de trabajo: 2 – 6 kg/cm²
Water Requirement / Requerimientos de agua: 9 m³/h – 32 m³/h
Nozzles / Boquilla: 12mm – 14mm – 16mm – 18mm
Body Angle / Cuerpo Ángulo: 27°

Atom35												
Nozzle diameter Diamètre de la bluse Diámetro de la tobera Durchmesser der Hauptdüse Diametro ugello		Pressure Pression Presión Wasserdruck im Beregner Pressione		Jet Length Portée Chorro Tragweite Gittata		Capacity Débit Capacidad Kapazität Portata			Values for a single sprinkler Données pour 1 arros. tout seul Datos para cada rociador Technische Daten für Einzelberegner Dati relativi ad 1 irrigatore			
									Irrigated area Surface arrosée Superficie irrigada Beregnete Fläche Superficie irrigata		Rainfall per hour Pluviométrie horaire Intensidad horaira Wassermenge pro Stund Intensità oraria	
mm	inch	kg/cm ²	lbs/inch	m	feet	l/min	m ³ /h	G.P.M.	m ²	acre	mm/h	
12	.47	2	29	20.0	66	155	9.3	41	1256	0.31	7.4	
	.47	3	44	24.0	79	187	11.2	49	1809	0.45	6.2	
	.47	4	56	27.0	89	217	13.0	57	2289	0.57	5.7	
	.47	5	70	28.0	92	237	14.2	63	2462	0.61	5.8	
14	.55	2	29	21.0	69	202	12.1	53	1385	0.34	8.7	
	.55	3	44	25.0	82	242	14.5	64	1963	0.48	7.4	
	.55	4	56	29.0	95	282	16.9	74	2641	0.65	6.4	
16	.55	5	70	30.0	98	315	18.9	83	2826	0.70	6.7	
	.62	2	29	22.0	72	253	15.2	67	1520	0.38	10.0	
	.62	3	44	26.0	85	315	18.9	83	2123	0.52	8.9	
18	.62	4	56	30.0	98	358	21.5	95	2826	0.70	7.6	
	.62	5	70	32.0	105	400	24.0	106	3215	0.79	7.5	
	.70	3	44	27.0	89	385	23.1	102	2289	0.57	10.1	
18	.70	4	56	30.0	98	450	27.0	119	2826	0.70	9.6	
	.70	5	70	34.0	112	502	30.1	133	3630	0.90	8.3	
	.70	6	85	35.0	115	542	32.5	143	3847	0.95	8.4	

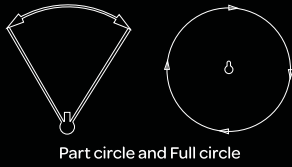

Part circle and Full circle

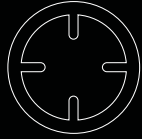

Barrel cross section

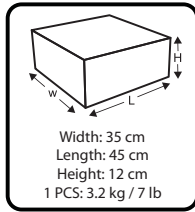

Aluminium Nozzles



ATOM 40S

Water Input / El agua de entrada: 2"
 Working Pressure / Presión de trabajo: 2 – 5 kg/cm²
 Water Requirement / Requerimientos de agua: 11 m³/h – 32 m³/h
 Nozzles / Boquilla: 14mm –15.2mm –16.5mm –17.8 mm – 19.1mm – 20.3mm
 Body Angle / Cuerpo Ángulo: 24°

Atom40 - 24° Trajectory

Nozzle diameter Diamètre de la bluse Diámetro de la tobera Durchmesser der Hauptdüse Diametro ugello		Pressure Pression Presiòn Wasserdruck im Beregner Pressione		Jet Length Portée Chorro Tragweite Gittata		Capacity Débit Capacidad Portata			Values for a single sprinkler Données pour 1 arros. tout seul Datos para cada rociador Technische Daten für Einzelberegner Dati relativi ad 1 irrigatore		
									Irrigated area Surface arrosée Superficie irrigada Beregnete Fläche Superficie irrigata		Rainfall per hour Pluviométrie horaire Intensidad horaira Wassermenge pro Stund Intensità oraria
mm	inch	kg/cm ²	lbs/inch	m	feet	l/min	m ³ /h	G.P.M.	m ²	acre	mm/h
14	0.55	2	29	22.0	72	195	11.7	52	1520	0.38	7.7
	0.55	3	44	25.0	82	238	14.3	63	1963	0.48	7.3
	0.55	4	56	28.0	92	277	16.6	73	2462	0.61	6.7
	0.55	5	70	30.0	98	308	18.5	81	2826	0.70	6.5
15.2	0.60	2	29	23.0	75	195	11.7	52	1661	0.41	7.0
	0.60	3	44	26.5	87	238	14.3	63	2205	0.54	6.5
	0.60	4	56	29.5	97	277	16.6	73	2733	0.67	6.1
	0.60	5	70	32.0	105	308	18.5	81	3215	0.79	5.8
16.5	0.65	2	29	24.0	79	247	14.8	65	1809	0.45	8.2
	0.65	3	44	28.0	92	303	18.2	80	2462	0.61	7.4
	0.65	4	56	31.0	102	350	21.0	92	3018	0.75	7.0
	0.65	5	70	34.0	112	390	23.4	103	3630	0.90	6.4
17.8	0.70	2	29	24.0	79	308	18.5	81	1809	0.45	10.2
	0.70	3	44	29.0	95	378	22.7	100	2641	0.65	8.6
	0.70	4	56	32.4	106	437	26.2	115	3296	0.81	7.9
	0.70	5	70	33.5	110	487	29.2	129	3524	0.87	8.3
19.1	0.75	2	29	25.2	83	308	18.5	81	1994	0.49	9.3
	0.75	3	44	29.0	95	378	22.7	100	2641	0.65	8.6
	0.75	4	56	32.0	105	437	26.2	115	3215	0.79	8.1
	0.75	5	70	34.0	112	487	29.2	129	3630	0.90	8.0
20.3	0.80	3	44	26.0	85	375	22.5	99	2123	0.52	10.6
	0.80	4	56	30.6	100	460	27.6	122	2940	0.73	9.4
	0.80	5	70	36.0	118	532	31.9	140	4069	1.01	7.8
	0.80	6	85	39.0	128	617	37.0	163	4776	1.18	7.7

The technical tables was created in zero wind conditions. The test tripod height is 1.2 Meters / Se crearon tablas técnicas en condiciones de viento cero. La altura del trípode de prueba es de 1,2 metros.

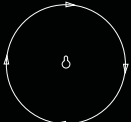

Full circle

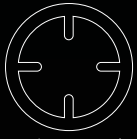

Barrel cross section

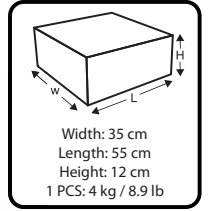

ATOM 42FC

Water Input / El agua de entrada: 2"
 Working Pressure / Presión de trabajo: 2 – 5 kg/cm²
 Water Requirement / Requerimientos de agua: 11 m³/h – 49 m³/h
 Nozzles / Boquilla: 14mm – 16mm – 18mm – 20mm – 22mm
 Body Angle / Cuerpo Ángulo: 28°

Atom 42 FC											
Meme Çapı Nozzle diameter Diamètre de la bluse Diámetro de la tobera Durchmesser der Hauptdüse Diametro ugello		Çalışma Basıncı Pressure Pression Presión Wasserdruck im Beregner Pressione		Atış Yarı Çapı Jet Length Portée Chorro Tragweite Gittata		Kapasite Capacity Débit Capacidad Kapazität Portata			Values for a single sprinkler Données pour 1 arros. tout seul Datos para cada rociador Technische Daten für Einzelberegner Dati relativi ad 1 irrigatore		
									Sulanan Alan Irrigated area Surface arrosée Superficie irrigada Beregnete Fläche Superficie irrigata		Yağış Miktarı Rainfall per hour Pluviométrie horaire Intensidad horaira Wassermenge pro Stund Intensità oraria
mm	inch	kg/cm ²	lbs/inch	m	feet	l/min	m ³ /h	G.P.M.	m ²	acre	mm/h
14	0.55	2	29	22	72	195	11.7	52	1520	0.38	7.7
	0.55	3	44	28	92	239	14.3	63	2462	0.61	5.8
	0.55	4	56	30	98	277	16.6	73	2826	0.70	5.9
	0.55	5	70	33	108	309	18.5	81	3419	0.84	5.4
16	0.63	2	29	24	79	247	14.8	65	1809	0.45	8.2
	0.63	3	44	30	98	303	18.2	80	2826	0.70	6.4
	0.63	4	56	33	108	351	21.0	92	3419	0.84	6.1
	0.63	5	70	35	115	391	23.4	103	3847	0.95	6.1
18	0.71	3	44	30	98	378	22.7	100	2826	0.70	8.0
	0.71	4	56	33	108	436	26.2	115	3419	0.84	7.7
	0.71	5	70	36	118	487	29.2	129	4069	1.01	7.2
20	0.79	3	44	31	102	460	27.6	122	3018	0.75	9.1
	0.79	4	56	35	115	532	31.9	140	3847	0.95	8.3
	0.79	5	70	40	131	594	35.6	157	5024	1.24	7.1
22	0.86	4	56	39	128	680	40.8	180	4776	1.18	8.5
	0.86	5	70	42	138	750	45	198	5539	1.37	8.1
	0.86	6	85	44	144	817	49	216	6079	1.50	8.1

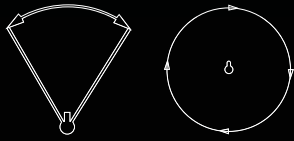

Part circle and Full circle

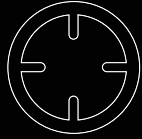

Barrel cross section

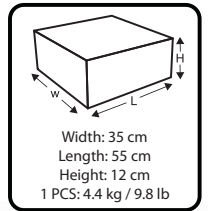

ATOM 42PC

Water Input / El agua de entrada: 2"
 Working Pressure / Presión de trabajo: 2 – 5 kg/cm²
 Water Requirement / Requerimientos de agua: 11 m³/h – 51 m³/h
 Nozzles / Boquilla: 14mm – 16mm – 18mm – 20mm – 22mm – 24mm
 Body Angle / Cuerpo Ángulo: 28°

Atom 42 FC											
Meme Çapı Nozzle diameter Diamètre de la bluse Diámetro de la tobera Durchmesser der Hauptdüse Diametro ugello		Çalışma Basıncı Pressure Pression Presión Wasserdruck im Beregner Pressione		Atış Yarı Çapı Jet Length Portée Chorro Tragweite Gittata		Kapasite Capacity Débit Capacidad Kapazitätä Portata			Values for a single sprinkler Données pour 1 arros. tout seul Datos para cada rociador Technische Daten für Einzelberegner Dati relativi ad 1 irrigatore		
									Sulanan Alan Irrigated area Surface arrosée Superficie irrigada Beregnete Fläche Superficie irrigata		Yağış Miktarı Rainfall per hour Pluviométrie horaire Intensidad horaira Wassermenge pro Stund Intensità oraria
mm	inch	kg/cm ²	lbs/inch	m	feet	l/min	m ³ /h	G.P.M.	m ²	acre	mm/h
14	0.55	2	29	22	72	195	11.7	52	1520	0.38	7.7
	0.55	3	44	28	92	239	14.3	63	2462	0.61	5.8
	0.55	4	56	30	98	277	16.6	73	2826	0.70	5.9
	0.55	5	70	33	108	309	18.5	81	3419	0.84	5.4
16	0.63	2	29	24	79	247	14.8	65	1809	0.45	8.2
	0.63	3	44	30	98	303	18.2	80	2826	0.70	6.4
	0.63	4	56	33	108	351	21.0	92	3419	0.84	6.1
	0.63	5	70	35	115	391	23.4	103	3847	0.95	6.1
18	0.71	3	44	30	98	378	22.7	100	2826	0.70	8.0
	0.71	4	56	33	108	436	26.2	115	3419	0.84	7.7
	0.71	5	70	36	118	487	29.2	129	4069	1.01	7.2
20	0.79	3	44	31	102	460	27.6	122	3018	0.75	9.1
	0.79	4	56	35	115	532	31.9	140	3847	0.95	8.3
	0.79	5	70	40	131	594	35.6	157	5024	1.24	7.1
22	0.86	4	56	39	128	680	40.8	180	4776	1.18	8.5
	0.86	5	70	42	138	750	45	198	5539	1.37	8.1
	0.86	6	85	44	144	817	49	216	6079	1.50	8.1
24	0.95	3	44	37	121	667	40	176	4299	1.06	9.3
	0.95	4	56	40	131	767	46	203	5024	1.24	9.2
	0.95	5	70	44	144	850	51	225	6079	1.50	8.4

CIT Tested
Center of Irrigation Technologies
Fresno , California / USA



Model Name : Atom14WFC

Nozzle Diameter : 3,6mm X 2.5mm, Pressure 2 bar / 29psi
Option 1- Triangular Pattern : 10meter X 10meter Δ Cu92%
Option 2- Triangular Pattern : 12meter X 12meter □ Cu92%
Option 3- Rectangular Pattern : 10meter X 10meter □ Cu94%

Nozzle Diameter : 4mm x 2.5mm, Pressure 2 bar / 29psi
Option 1- Rectangular Pattern : 12meter X 12meter □ Cu91%
Option 2- Rectangular Pattern : 12meter X 18meter □ Cu89%
Option 3- Triangular Pattern : 10meter X 10meter Δ Cu91%
Option 4- Triangular Pattern : 12meter X 12meter Δ Cu89%
Option 5- Triangular Pattern : 15meter X 10meter Δ Cu92%

Nozzle Diameter : 4mm x2.5mm , Pressure 2.5 bar / 36psi
Option 1- Rectangular Pattern : 12meter X 12meter □ Cu94%
Option 2- Rectangular Pattern : 12meter X 18meter □ Cu92%
Option 3- Rectangular Pattern : 18meter X 18meter □ Cu91%
Option 4- Triangular Pattern : 12meter X 18meter Δ Cu95%
Option 5- Triangular Pattern : 12meter X 12meter Δ Cu93%

CIT Tested
Center of Irrigation Technologies
Fresno , California / USA



Model Name : Atom22

Nozzle Diameter : 6mm , Pressure 3 bar / 44psi
Option 1- Triangular Pattern : 15meter X 20meter Δ Cu92%
Option 2- Triangular Pattern : 18meter X 18meter Δ Cu82%
Option 3- Rectangular Pattern : 20meter X 20meter □ Cu86%
Option 4- Rectangular Pattern : 18meter X 24meter □ Cu84%

Nozzle Diameter : 8mm , Pressure 3 bar / 44psi
Option 1- Rectangular Pattern : 20meter X 20meter □ Cu81%
Option 2- Rectangular Pattern : 22meter X 22meter □ Cu84%
Option 3- Rectangular Pattern : 25meter X 25meter □ Cu84%
Option 4- Triangular Pattern : 18meter X 18meter Δ Cu87%
Option 5- Triangular Pattern : 20meter X 20meter Δ Cu80%

Nozzle Diameter : 8mm , Pressure 4 bar / 55psi
Option 1- Rectangular Pattern : 20meter X 20meter □ Cu83%
Option 2- Rectangular Pattern : 25meter X 20meter □ Cu87%
Option 3- Rectangular Pattern : 25meter X 25meter □ Cu87%
Option 4- Triangular Pattern : 18meter X 24meter Δ Cu89%

CIT Tested
Center of Irrigation Technologies
Fresno , California / USA



Model Name : Atom35

Nozzle Diameter : 14mm , Pressure 3 bar / 44psi
Option 1- Triangular Pattern : 45meter X 40meter Δ Cu81%
Option 2- Triangular Pattern : 25meter X 25meter Δ Cu87%
Option 3- Triangular Pattern : 27meter X 27meter Δ Cu86%
Option 4- Rectangular Pattern : 25meter X 25meter □ Cu85%
Option 5- Rectangular Pattern : 35meter X 35meter □ Cu91%

Nozzle Diameter : 14mm , Pressure 4 bar / 55psi
Option 1- Rectangular Pattern : 35meter X 35meter □ Cu87%
Option 2- Rectangular Pattern : 36meter X 36meter □ Cu88%
Option 3- Rectangular Pattern : 38meter X 38meter □ Cu87%
Option 4- Rectangular Pattern : 30meter X 40meter □ Cu87%
Option 5- Triangular Pattern : 30meter X 30meter Δ Cu87%

Nozzle Diameter : 14mm , Pressure 5 bar / 70psi
Option 1- Rectangular Pattern : 40meter X 35meter □ Cu91%
Option 2- Rectangular Pattern : 36meter X 36meter □ Cu91%
Option 3- Triangular Pattern : 42meter X 36meter Δ Cu90%
Option 4- Triangular Pattern : 36meter X 30meter Δ Cu91%

CIT Tested
Center of Irrigation Technologies
Fresno , California / USA



Model Name : Atom15FC

Nozzle Diameter : 5,5mm X 3.2mm, Pressure 3 bar / 43psi
Option 1- Rectangular Pattern : 12meter X 12meter □ Cu95%
Option 2- Triangular Pattern : 12meter X 12meter □ Cu93%
Option 3- Rectangular Pattern : 10meter X 10meter □ Cu92%

Nozzle Diameter : 6mm x 3.2mm, Pressure 3 bar / 43psi
Option 1- Rectangular Pattern : 10meter X 10meter □ Cu95%
Option 2- Rectangular Pattern : 12meter X 12meter □ Cu92%
Option 3- Triangular Pattern : 10meter X 10meter Δ Cu96%
Option 4- Triangular Pattern : 12meter X 12meter Δ Cu91%
Option 5- Triangular Pattern : 15meter X 10meter Δ Cu91%

Nozzle Diameter : 6mm x 3.2mm , Pressure 3.5 bar / 50psi
Option 1- Rectangular Pattern : 12meter X 12meter □ Cu94%
Option 2- Rectangular Pattern : 12meter X 15meter □ Cu91%
Option 3- Triangular Pattern : 12meter X 12meter Δ Cu95%
Option 4- Triangular Pattern : 15meter X 15meter Δ Cu91%

CIT Tested
Center of Irrigation Technologies
Fresno , California / USA



Model Name : Atom28

Nozzle Diameter : 12mm , Pressure 3 bar / 44psi
Option 1- Triangular Pattern : 20meter X 20meter Δ Cu91%
Option 2- Triangular Pattern : 35meter X 35meter Δ Cu85%
Option 3- Rectangular Pattern : 24meter X 30meter □ Cu84%
Option 4- Rectangular Pattern : 24meter X 32meter □ Cu85%

Nozzle Diameter : 14mm , Pressure 3 bar / 44psi
Option 1- Rectangular Pattern : 21meter X 24meter □ Cu90%
Option 2- Rectangular Pattern : 20meter X 25meter □ Cu87%
Option 3- Rectangular Pattern : 25meter X 25meter □ Cu84%
Option 4- Triangular Pattern : 24meter X 24meter Δ Cu91%
Option 5- Triangular Pattern : 20meter X 25meter Δ Cu94%

Nozzle Diameter : 14mm , Pressure 4 bar / 55psi
Option 1- Rectangular Pattern : 25meter X 25meter □ Cu87%
Option 2- Rectangular Pattern : 30meter X 30meter □ Cu89%
Option 3- Triangular Pattern : 24meter X 24meter Δ Cu92%
Option 4- Triangular Pattern : 36meter X 30meter Δ Cu89%

CIT Tested
Center of Irrigation Technologies
Fresno , California / USA

Model Name : JET50

Nozzle Diameter : 20mm , Pressure 3 bar / 44psi
Option 1- Triangular Pattern : 45meter X 45meter Δ Cu83%
Option 2- Triangular Pattern : 42meter X 42meter Δ Cu82%

Nozzle Diameter : 20mm , Pressure 5 bar / 70psi
Option 1- Triangular Pattern : 50meter X 50meter Δ Cu89%
Option 2- Triangular Pattern : 55meter X 45meter Δ Cu90%
Option 3- Rectangular Pattern : 50meter X 50meter □ Cu82%

Model Name : JET65

Nozzle Diameter : 24mm , Pressure 5 bar / 70psi
Option 1- Triangular Pattern : 72meter X 66meter Δ Cu87%
Option 2- Triangular Pattern : 66meter X 66meter Δ Cu84%
Option 3- Triangular Pattern : 70meter X 60meter Δ Cu77%
Option 4- Rectangular Pattern : 72meter X 66meter □ Cu77%

Model Name : JET65

Nozzle Diameter : 24mm , Pressure 6 bar / 85psi
Option 1- Triangular Pattern : 78meter X 68meter Δ Cu84%

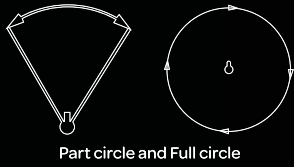

Part circle and Full circle

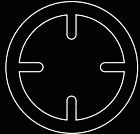

Barrel cross section

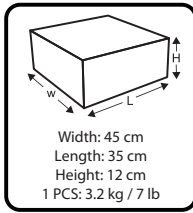

Width: 45 cm
Length: 35 cm
Height: 12 cm
1 PCS: 3.2 kg / 7 lb



Aluminium Nozzles



RED ATOM 40S

Water Input / El agua de entrada: 2"
 Working Pressure / Presión de trabajo: 2 – 5 kg/cm²
 Water Requirement / Requerimientos de agua: 11 m³/h – 32 m³/h
 Nozzles / Boquilla: 14mm – 15.2mm – 16.5mm – 17.8mm – 19.1mm – 20.3mm
 Body Angle / Cuerpo Ángulo: 24°

Atom40 - 24° Trajectory

Nozzle diameter Diamètre de la bluse Diámetro de la tobera Durchmesser der Hauptdüse Diametro ugello		Pressure Pression Presión Wasserdruck im Beregner Pressione		Jet Length Portée Chorro Tragweite Gittata		Capacity Débit Capacidad Kapazität Portata			Values for a single sprinkler Données pour 1 arros. tout seul Datos para cada rociador Technische Daten für Einzelberegner Dati relativi ad 1 irrigatore		
									Irrigated area Surface arrosée Superficie irrigada Beregnete Fläche Superficie irrigata		Rainfall per hour Pluviométrie horaire Intensidad horaira Wassermenge pro Stund Intensità oraria
mm	inch	kg/cm ²	lbs/inch	m	feet	l/min	m ³ /h	G.P.M.	m ²	acre	mm/h
14	0.55	2	29	22.0	72	195	11.7	52	1520	0.38	7.7
	0.55	3	44	25.0	82	238	14.3	63	1963	0.48	7.3
	0.55	4	56	28.0	92	277	16.6	73	2462	0.61	6.7
	0.55	5	70	30.0	98	308	18.5	81	2826	0.70	6.5
15.2	0.60	2	29	23.0	75	195	11.7	52	1661	0.41	7.0
	0.60	3	44	26.5	87	238	14.3	63	2205	0.54	6.5
	0.60	4	56	29.5	97	277	16.6	73	2733	0.67	6.1
	0.60	5	70	32.0	105	308	18.5	81	3215	0.79	5.8
16.5	0.65	2	29	24.0	79	247	14.8	65	1809	0.45	8.2
	0.65	3	44	28.0	92	303	18.2	80	2462	0.61	7.4
	0.65	4	56	31.0	102	350	21.0	92	3018	0.75	7.0
	0.65	5	70	34.0	112	390	23.4	103	3630	0.90	6.4
17.8	0.70	2	29	24.0	79	308	18.5	81	1809	0.45	10.2
	0.70	3	44	29.0	95	378	22.7	100	2641	0.65	8.6
	0.70	4	56	32.4	106	437	26.2	115	3296	0.81	7.9
	0.70	5	70	33.5	110	487	29.2	129	3524	0.87	8.3
19.1	0.75	2	29	25.2	83	308	18.5	81	1994	0.49	9.3
	0.75	3	44	29.0	95	378	22.7	100	2641	0.65	8.6
	0.75	4	56	32.0	105	437	26.2	115	3215	0.79	8.1
	0.75	5	70	34.0	112	487	29.2	129	3630	0.90	8.0
20.3	0.80	3	44	26.0	85	375	22.5	99	2123	0.52	10.6
	0.80	4	56	30.6	100	460	27.6	122	2940	0.73	9.4
	0.80	5	70	36.0	118	532	31.9	140	4069	1.01	7.8
	0.80	6	85	39.0	128	617	37.0	163	4776	1.18	7.7

The technical tables was created in zero wind conditions. The test tripod height is 1.2 Meters / Se crearon tablas técnicas en condiciones de viento cero. La altura del trípode de prueba es de 1,2 metros.

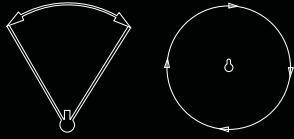

Part circle and Full circle

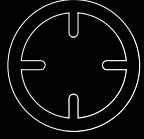

Barrel cross section

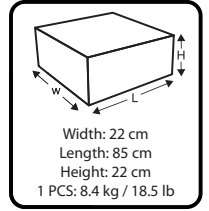

DUST JET 27°

Water Input / El agua de entrada: 2"
 Working Pressure / Presión de trabajo: 3 – 7 kg/cm²
 Water Requirement / Requerimientos de agua: 23 m³/h – 76 m³/h
 Nozzles / Boquilla: 18mm – 20mm – 22mm – 24mm – 26mm – 28mm
 Body Angle / Cuerpo Ángulo: 27°

DUST JET 27°													
Meme Çapı diameter Diamètre de la bluse Diámetro de la tobera Durchmesser der Hauptdüse Diametro ugello		Basınç Pressure Pression Presión Wasserdruck im Beregnen Pressione		Atış Yarı Çapı Jet Length Portée Chorro Tragweite Gittata		Su Tüketimi Capacity Débit Capacidad Kapazität Portata			Değerler bir Fıskiye içindir Values for a single sprinkler Données pour 1 arros. tout seul Datos para cada rociador Technische Daten für Einzelberegner Dati relativi ad 1 irrigatore				
									Sulanan Alan Irrigated area Surface arrosée Superficie irrigada Beregnete Fläche Superficie irrigata		Yağış Miktarı Rainfall per hour Pluviométrie horaire Intensidad horaira Wassermenge pro Stund Intensità oraria		
mm	inch	kg/cm ²	lbs/inch	m	feet	l/min	m ³ /h	G.P.M.	m ²	acre	mm/h		
18	0.7	3	44	32	105	390	23.4	103	3215	0.79	7.3		
	0.7	4	56	35	115	445	26.7	118	3847	0.95	6.9		
	0.7	5	70	37	121	498.33	29.9	132	4299	1.06	7.0		
	0.7	6	85	39	128	553.33	33.2	146	4776	1.18	7.0		
20	0.78	3	44	35	115	463.33	27.8	122	3847	0.95	7.2		
	0.78	4	56	38	125	548.33	32.9	145	4534	1.12	7.3		
	0.78	5	70	42	138	616.67	37	163	5539	1.37	6.7		
	0.78	6	85	43	141	666.67	40	176	5806	1.43	6.9		
22	0.86	4	56	40	131	680	40.8	180	5024	1.24	8.1		
	0.86	5	70	44	144	753.33	45.2	199	6079	1.50	7.4		
	0.86	6	85	47	154	818.33	49.1	216	6936	1.71	7.1		
24	0.94	5	70	43	141	816.67	49	216	5806	1.43	8.4		
	0.94	6	85	45	148	900	54	238	6359	1.57	8.5		
	0.94	7	100	46	151	933.33	56	247	6644	1.64	8.4		
26	1.02	4	56	43	141	883.3	53	233	5806	1.43	9.1		
	1.02	5	70	45	148	950.0	57	251	6359	1.57	9.0		
	1.02	6	85	48	157	1050.0	63	277	7235	1.79	8.7		
28	1.1	5	70	47	154	1083.3	65	286	6936	1.71	9.4		
	1.1	6	85	50	164	1200.0	72	317	7850	1.94	9.2		
	1.1	7	100	53	174	1266.7	76	335	8820	2.18	8.6		

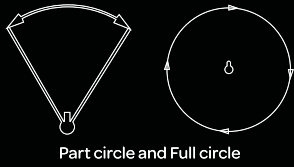

Part circle and Full circle

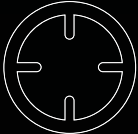

Barrel cross section

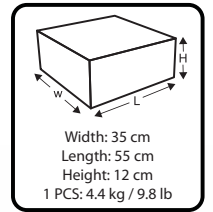

ATOM 42 DUST

Water Input / El agua de entrada: 2"
 Working Pressure / Presión de trabajo: 3 – 7 kg/cm²
 Water Requirement / Requerimientos de agua: 15 m³/h – 58 m³/h
 Nozzles / Boquilla: 14mm – 16mm – 18mm – 20mm – 22mm – 24mm
 Body Angle / Cuerpo Ángulo: 43°

ATOM 42 DUST												
Nozzle diameter Diamètre de la bluse / Diámetro de la tobera / Durchmesser der Hauptdüse / Diametro ugello		Pressure Pression / Presión / Wasserdruck im Beregner / Pressione		Jet Length Portée / Chorro / Tragweite / Gittata		Capacity Débit / Capacidad / Kapazität / Portata						
mm	inch	kg/cm ²	lbs/inch	m	feet	l/min	m ³ /h	G.P.M.	H Maximum Height Hauteur maximale / Altura máxima / maximale Höhe / Altezza massima		DH Distance at the soil from sprinkler to apogee Distance au stop entre canon et apogée / Distancia al suelo entre aspersor y apogeo / Bodensabstand zwischen regner und erdferne	
									m	feet	Metre	feet
14	.55	3	44	27.5	90	250	15	66	9.5	31	16	52
	.55	4	56	30.5	100	287	17.2	76	11.5	38	18	59
	.55	5	70	32.5	107	322	19.3	85	13.5	44	20	66
	.55	6	85	34	112	343	20.6	91	14.5	48	22	72
16	.62	3	44	30.5	100	313	18.8	83	10.5	34	17	56
	.62	4	56	33.5	110	358	21.5	95	12.5	41	19	62
	.62	5	70	35	115	403	24.2	107	14.0	46	21	69
18	.62	6	85	37.5	123	425	25.5	112	16.0	52	24	79
	.70	4	56	35.5	116	467	28	123	13.0	43	21	69
	.70	5	70	37.5	123	493	29.6	130	15.0	49	23	75
20	.70	6	85	40	131	543	32.6	144	17.0	56	25	82
	.78	3	44	33.5	110	462	27.7	122	11.0	36	21	69
	.78	4	56	37	121	553	33.2	146	13.5	44	22	72
22	.78	5	70	39.5	130	608	36.5	161	15.5	51	24	79
	.78	6	85	42	138	632	37.9	167	16.5	54	27	89
	.86	3	44	35	115	573	34.4	151	11.0	36	22	72
24	.86	4	56	38.5	126	658	39.5	174	13.5	44	24	79
	.86	5	70	41	134	733	44	194	16.0	52	26	85
	.86	6	85	43	141	767	46	203	18.0	59	28	92
24	.94	4	56	39	128	788	47.3	208	14.0	46	26	85
	.94	5	70	41.5	136	818	49.1	216	16.5	54	29	95
	.94	6	85	45	148	902	54.1	238	18.5	61	31	102
	.94	7	100	47	154	967	58	255	21.0	69	33	108

The technical tables was created in zero wind conditions. The test tripod height is 1.2 Meters / Se crearon tablas técnicas en condiciones de viento cero. La altura del trípode de prueba es de 1,2 metros.

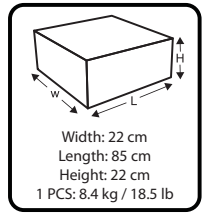
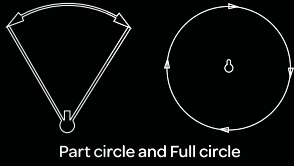

DUST JET 43°

Water Input / El agua de entrada: 2"
Working Pressure / Presión de trabajo: 3 – 7 kg/cm²
Water Requirement / Requerimientos de agua: 15 m³/h – 58 m³/h
Nozzles / Boquilla: 14mm – 16mm – 18mm – 20mm – 22mm – 24mm
Body Angle / Cuerpo Ángulo: 43°

DUSTJET 43°													
Nozzle diameter Diamètre de la bluse / Diámetro de la tobera / Durchmesser der Hauptdüse / Diametro ugello		Pressure Pression / Presión / Wasserdruck im Beregner / Pressione		Jet Length Portée / Chorro / Tragweite / Gittata		Capacity Débit / Capacidad / Kapazität / Portata							
									H Maximum Height Hauteur maximale / Altura máxima / maximale Höhe / Altezza massima		DH Distance at the soil from sprinkler to apogee Distance au stop entre canon et apogée / Distancia al suelo entre aspersor y apogeo / Bodensabstand zwischen regner und erdferne		
mm	inch	kg/cm ²	lbs/inch	m	feet	l/min	m ³ /h	G.P.M.	m	feet	Metre	feet	
14	.55	3	44	27.5	90	250	15	66	9.5	31	16	52	
	.55	4	56	30.5	100	287	17.2	76	11.5	38	18	59	
	.55	5	70	32.5	107	322	19.3	85	13.5	44	20	66	
	.55	6	85	34	112	343	20.6	91	14.5	48	22	72	
16	.62	3	44	30.5	100	313	18.8	83	10.5	34	17	56	
	.62	4	56	33.5	110	358	21.5	95	12.5	41	19	62	
	.62	5	70	35	115	403	24.2	107	14.0	46	21	69	
18	.62	6	85	37.5	123	425	25.5	112	16.0	52	24	79	
	.70	4	56	35.5	116	467	28	123	13.0	43	21	69	
	.70	5	70	37.5	123	493	29.6	130	15.0	49	23	75	
20	.70	6	85	40	131	543	32.6	144	17.0	56	25	82	
	.78	3	44	33.5	110	462	27.7	122	11.0	36	21	69	
	.78	4	56	37	121	553	33.2	146	13.5	44	22	72	
	.78	5	70	39.5	130	608	36.5	161	15.5	51	24	79	
22	.78	6	85	42	138	632	37.9	167	16.5	54	27	89	
	.86	3	44	35	115	573	34.4	151	11.0	36	22	72	
	.86	4	56	38.5	126	658	39.5	174	13.5	44	24	79	
	.86	5	70	41	134	733	44	194	16.0	52	26	85	
24	.86	6	85	43	141	767	46	203	18.0	59	28	92	
	.94	4	56	39	128	788	47.3	208	14.0	46	26	85	
	.94	5	70	41.5	136	818	49.1	216	16.5	54	29	95	
	.94	6	85	45	148	902	54.1	238	18.5	61	31	102	
	.94	7	100	47	154	967	58	255	21.0	69	33	108	

The technical tables was created in zero wind conditions. The test tripod height is 1.2 Meters / Se crearon tablas técnicas en condiciones de viento cero. La altura del trípode de prueba es de 1,2 metros.

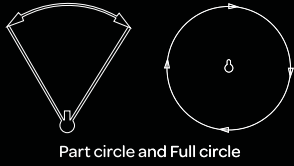

Part circle and Full circle

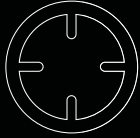

Barrel cross section

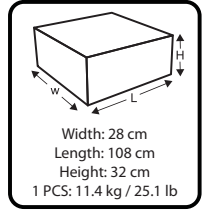

SUPER DUST JET 43°

Water Input / El agua de entrada: Flange 130mmx78mm "
Working Pressure / Presión de trabajo: 3 – 7 kg/cm²
Water Requirement / Requerimientos de agua: 41 m³/h – 108 m³/h
Nozzles / Boquilla: 24mm – 26mm – 28mm – 30mm – 32mm
Body Angle / Cuerpo Ángulo: 43°

Super Dustjet 43°												
Nozzle diameter Diamètre de la bluse Diámetro de la tobera Durchmesser der Hauptdüse Diametro ugello		Pressure Pression Presión Wasserdruck im Beregner Pressione		Jet Length Portée Chorro Tragweite Gittata		Capacity Débit Capacidad Kapazität Portata						
									H Maximum Height Hauteur maximale Altura máxima maximale Höhe Altezza massima	DH Distance at the soil from sprinkler to apogee Distance au stop entre canon et apogée Distancia al suelo entre aspensor y apogeo Bodensabstand zwischen regner und erdferne		
mm	inch	kg/cm ²	lbs/inch	m	feet	l/min	m ³ /h	G.P.M.	m	feet	Metre	feet
24	0.95	3	44	38	125	683	41	181	12.0	39	22	72
	0.95	4	56	40	131	800	48	211	14.0	46	25	82
	0.95	5	70	42	138	917	55	242	16.0	52	27	89
	0.95	6	85	44	144	983	59	260	18.0	59	30	98
26	1.03	3	44	37	121	800	48	211	13.0	43	23	75
	1.03	4	56	42	138	933	56	247	15.0	49	27	89
	1.03	5	70	45	148	1050	63	277	17.0	56	28	92
	1.03	6	85	48	157	1133	68	299	18.0	59	30	98
28	1.1	3	44	38	125	933	56	247	18.0	59	24	79
	1.1	4	56	44	144	1083	65	286	16.0	52	27	89
	1.1	5	70	47	154	1200	72	317	17.0	56	29	95
	1.1	6	85	50	164	1300	78	343	19.0	62	31	102
30	1.18	4	56	46	151	1200	72	317	16.0	52	27	89
	1.18	5	70	49	161	1350	81	357	18.0	59	30	98
	1.18	6	85	52	171	1483	89	392	19.0	62	32	105
32	1.25	4	56	47	154	1333	80	352	17.0	56	28	92
	1.25	5	70	50	164	1533	92	405	19.0	62	31	102
	1.25	6	85	54	177	1667	100	440	21.0	69	33	108
	1.25	7	100	56	184	1800	108	476	22.5	74	35	115

The technical tables was created in zero wind conditions. The test tripod height is 1.2 Meters / Se crearon tablas técnicas en condiciones de viento cero. La altura del trípode de prueba es de 1,2 metros.

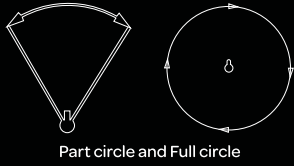

Part circle and Full circle

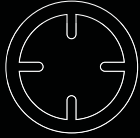

Barrel cross section

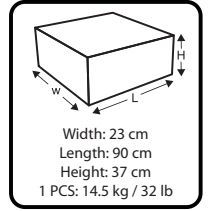

FIRE JET

Water Input / El agua de entrada: Flange 145mmx78mm"
Working Pressure / Presión de trabajo: 4 – 8 kg/cm²
Water Requirement / Requerimientos de agua: 70 m³/h – 150 m³/h
Nozzles / Boquilla: 30mm – 32mm – 34mm – 36mm
Body Angle / Cuerpo Ángulo: 23°

Yuzuak FIREJET												
Meme Çapı Nozzle diameter Diamètre de la bluse Diámetro de la tobera Durchmesser der Hauptdüse Diametro ugello		Basınç Pressure Pression Presiòn Wasserdruck im Beregnen Pressione		Atış Yarı Çapı Jet Length Portée Chorro Tragweite Gittata		Su Tüketimi Capacity Débit Capacidad Kapazität Portata			Değerler bir Fıskiye içindir Values for a single sprinkler Données pour 1 arros. tout seul Datos para cada rociador Technische Daten für Einzelberegne Dati relativi ad 1 irrigatore			
									Sulanan Alan Irrigated area Surface arrosée Superficie irrigada Beregnete Fläche Superficie irrigata		Yağış Miktarı Rainfall per hour Pluviométrie horaire Intensidad horaira Wassermenge pro Stund Intensità oraria	
mm	inch	kg/cm ²	lbs/inch	m	feet	l/min	m ³ /h	G.P.M.	m ²	acre	mm/h	
30	1.18	4	56	49	161	1220	73.2	322	7539	1.86	9.7	
	1.18	5	70	52	171	1383	83	365	8491	2.10	9.8	
	1.18	6	85	57	187	1488	89.3	393	10202	2.52	8.8	
32	1.25	4	56	51	167	1383	83	365	8167	2.02	10.2	
	1.25	5	70	55	180	1550	93	409	9499	2.35	9.8	
	1.25	6	85	60	197	1733	104	458	11304	2.79	9.2	
	1.25	7	100	63	207	1850	111	489	12463	3.08	8.9	
34	1.33	5	70	57	187	1750	105	462	10202	2.52	10.3	
	1.33	6	85	60	197	1950	117	515	11304	2.79	10.4	
	1.33	7	100	64	210	2033	122	537	12861	3.18	9.5	
36	1.42	6	85	62	203	2117	127	559	12070	2.98	10.5	
	1.42	7	100	66	216	2253	135	595	13678	3.38	9.9	
	1.42	8	114	70	230	2435	146	643	15386	3.80	9.5	

PASTURE MASTER TD1000-100

Easy way for irrigation
New Design Traveller Irrigator
IRRIFORCE



PASTURE MASTER TD1250-120

Easy way for irrigation
New Design Traveller Irrigator
IRRIFORCE



PASTURE MASTER TD1500-130

Easy way for irrigation
New Design Traveller Irrigator
IRRIFORCE



Pasture Master TD1000-100 RAINFALL AND VELOCITY RELATIONS TABLE

Sprinkler Type : Yuzuak Atom22
 Hose Diameter and Length : Diameter : 25 mm (1 ") ; Length : 50 meters
 Traveller Length : 100 meters

Nozzle Size	Sprinkler Pressure		Sprinkler Throw Range		% 85 of Throw Diameter of Sprinkler		Capacity			Irriforce Lineer Velocity		Total Pressure Neccesity		Turbine + Hose Pressure Lost		Rainfall (mm)		Total Operation Time for travel (hour)	
							Flow Rate												
							Bar	Psi	m										
8 mm	2.5	36	16.5	54	28	92	63	3.8	16	19	62	4.0	58	1.5	22	6.5	0.26	5.3	5.3
	3	44	18	59	31	100	68	4.1	18	40	131	4.9	71	1.9	28	3.0	0.12	2.5	2.5
	4	58	19	62	32	106	80	4.8	21	55	180	7.0	102	3.0	44	2.4	0.10	1.8	1.8
6 mm +4mm	3	44	17	56	29	95	57	3.4	15	39	128	5.2	75	2.2	32	2.8	0.11	2.6	2.6
	4	58	18	59	31	100	65	3.9	17	60	197	6.6	96	2.6	38	1.9	0.08	1.7	1.7
	4.5	65	18.5	61	31	103	70	4.2	18	70	230	7.7	112	3.2	46	1.7	0.07	1.4	1.4

Pasture Master TD1250-120 RAINFALL AND VELOCITY RELATIONS TABLE

Sprinkler Type : Yuzuak Atom22
 Hose Diameter and Length : Diameter : 32 mm (1 1/4 ") ; Length : 60 meters
 Traveller Length : 120 meters

Nozzle Size	Sprinkler Pressure		Sprinkler Throw Range		% 85 of Throw Diameter of Sprinkler		Capacity			Irriforce Lineer Velocity		Total Pressure Neccesity		Turbine + Hose Pressure Lost		Rainfall (mm)		Total Operation Time for travel (hour)	
							Flow Rate												
							Bar	Psi	m										
8 mm	2.5	36	16.5	54	28	92	63	3.8	16	19	62	3.8	55	1.3	19	6.5	0.26	6.4	6.3
	3	44	18	59	31	100	68	4.1	18	40	131	4.6	67	1.6	23	3.0	0.12	3.0	3.0
	4	58	19	62	32	106	80	4.8	21	55	180	6.6	96	2.6	38	2.4	0.10	2.2	2.2
8 mm X 4mm	2.5	36	16.5	54	28	92	72	4.3	19	39	128	4.2	61	1.7	25	3.6	0.14	3.1	3.1
	3	44	18	59	31	100	87	5.2	23	60	197	5.7	83	2.7	39	2.6	0.10	2.0	2.0
	4	58	19	62	32	106	100	6	26	70	230	7.4	107	3.4	49	2.4	0.10	1.7	1.7
10 mm	2.5	36	17	56	29	95	98	5.9	26	82	269	5.4	78	2.9	42	2.3	0.09	1.5	1.5
	3	44	19.5	64	33	109	107	6.4	28	85	279	6.3	91	3.3	48	2.0	0.08	1.4	1.4
	3.5	51	20.5	67	35	114	117	7	30	95	312	7.6	110	4.1	59	1.9	0.08	1.3	1.3

* PS 1: The Table above was prepared with mathematical formulas and datas under average working conditions. It is targeted to give general information to the user. Real datas can be changed during using conditions. Yüzük Makine does not accept any responsibility according to usage of this Table.

Pasture Master TD1500-130 RAINFALL AND VELOCITY RELATIONS TABLE

Sprinkler Type : Yuzuak Atom 28 X 1.25"
 Hose Diameter and Length : Diameter 38 mm (1,5 ") ; Length : 65 meters
 Traveller Length : 130 Meter

Nozzle Size	Sprinkler Pressure		Sprinkler Throw Range		% 85 of Throw Diameter of Sprinkler		Capacity			Tribune Pressure Lost		Tribune Pressure Lost		Tribune Pressure Lost		Tribune Pressure Lost		Tribune Pressure Lost		Tribune Pressure Lost		Tribune Pressure Lost					
							Flow Rate			bar	psi	bar	psi	bar	psi	bar	psi	bar	psi	bar	psi	bar	psi	bar	psi	bar	psi
							l/min	m ³ /hour	GPM	mm	inch	mm	inch	mm	inch	mm	inch	mm	inch	mm	inch	mm	inch	mm	inch	mm	inch
10 mm	3	44	21	69	36	117	107	6.4	28	19	62	4.6	67	13	43	4.4	64	10	33	4.2	61	8	26	4.2	61		
	4	58	23	75	39	128	123	7.4	32	20	66	5.8	84	13	43	5.6	81	10	33	5.4	78	8	26	5.4	78		
12mm	2.5	36	20	66	34	112	142	8.5	37	23	74	4.5	65	15	50	4.3	62	11	37	4.1	59	9	30	4.1	59		
	3	44	24	79	41	134	157	9.4	41	21	67	5.1	74	14	45	4.9	71	10	34	4.7	68	8	27	4.7	68		
14mm	4	58	26	85	44	145	180	10.8	47	22	71	6.3	91	14	47	6.1	88	11	35	5.9	86	9	28	5.9	86		
	2	29	21	69	36	117	175	10.5	46	27	87	4.2	61	18	58	4	58	13	44	3.8	55	11	35	3.8	55		
	3	44	25	82	43	139	213	12.8	55	27	88	5.6	81	18	58	5.4	78	13	44	5.2	75	11	35	5.2	75		

* NOTE: The Table above was prepared with mathematical formulas and datas under average working conditions. It is targeted to give general information to the user. Real datas can be changed during using conditions. Yüzük Makine does not accept any responsibility according to usage of this Table.

Yüziak® Sprinklers

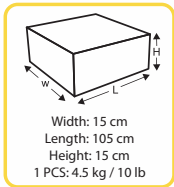

MINI ECO STAND 1''

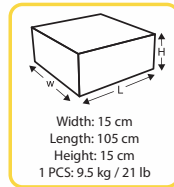
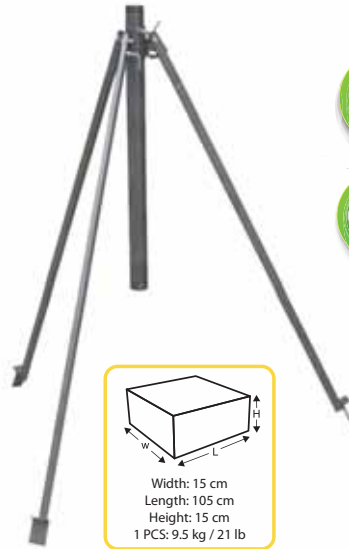

PRO ECO STAND 1,5''

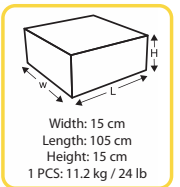

PRO ECO 4POD STAND 1,5''

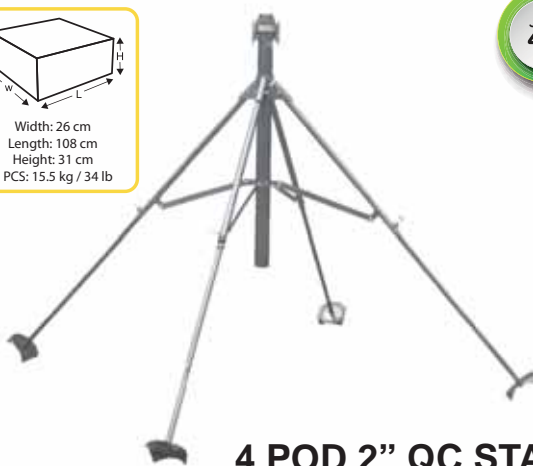
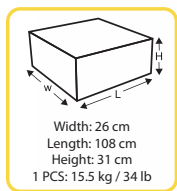

4 POD 2'' QC STAND

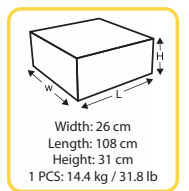

4 POD 2'' ECO STAND

Yüziak® Sprinklers



4 Pod High Stant With QC 2"



3 Pod Pro Eco High Stant 1.5"

Width: 26 cm
Length: 108 cm
Height: 31 cm
1 PCS: 16 kg / 35 lb

JET 70



4 POD 3" ECO STAND

Width: 26 cm
Length: 108 cm
Height: 31 cm
1 PCS: 15.2 kg / 33.5 lb

JET 55

JET 65

JET 65T



4 POD 2,5" ECO STAND



SLIDE BASE SPRINKLER

T POST STANT

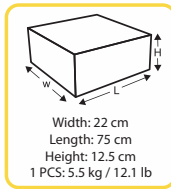

Width: 22 cm
Length: 75 cm
Height: 12.5 cm
1 PCS: 5.5 kg / 12.1 lb



WHEELED RAINGUN CARTS 1''

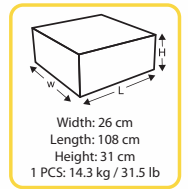

Width: 26 cm
Length: 108 cm
Height: 31 cm
1 PCS: 14.3 kg / 31.5 lb



WHEELED RAINGUN CARTS 1,5''

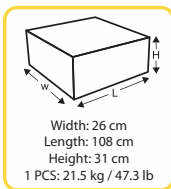

Width: 26 cm
Length: 108 cm
Height: 31 cm
1 PCS: 21.5 kg / 47.3 lb



WHEELED RAINGUN CARTS 2''

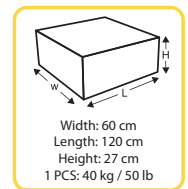

Width: 60 cm
Length: 120 cm
Height: 27 cm
1 PCS: 40 kg / 50 lb



**WHEELED RAINGUN CARTS 2''
WITH HOSE REEL**

Yüzüak® Sprinklers



Quick Coupling System For 1" NPT Or BSP Connection With Stop Valve

Available Size:

- Inlet 1" BSP or NPT Male Screw X Output Ø32 - B Part With Stop Valve
- Inlet 1" BSP or NPT Male Screw X Output Ø32 Male - A Part
- 1" Quick Coupling System Set (B Part + A Part)



SUCTION QUICK COUPLING SET

Available Size:

- Suction Quick Pump Side 76 mm Male BSP Or NPT Screw-Hose Side 76 mm Male with 2 pcs Clamp
- Suction Quick Pump Side 110 mm BSP Or NPT Male Screw-Hose Side 101 mm Male with 2 pcs Clamp
- Suction Quick Pump Side 125 mm BSP Or NPT Male Screw-Hose Side 125 mm Male with 2 pcs Clamp



1" Air Release Valve (NPT Or BSP)



2" Air Release Valve (NPT Or BSP)



Hydrant (NPT Or BSP)
Available Size: 2.5" - 3" - 4"



2"x2" quick Coupling (NPT or BSP)
2"x1.5" quick Coupling (NPT or BSP)



Movable Layflat Irrigation System

Aluminium Quick Coupler and HDPE Elbow , TE and Blind Plug

Sistema de irrigación móvil Layflat

Acople rápido de aluminio y codo HDPE, TE y tapón ciego



Aluminium couplers suitable for 52mm -76mm and 90mm Layflats

HDPE Parts Suitable for 63mm , 76mm and 90mm Connectors

For more information please contact with us

Acoples de aluminio adecuados para 52mm -76mm y 90mm Layflats

Piezas de HDPE adecuadas para conectores de 63 mm, 76 mm y 90 mm

Para mayor más información, póngase en contacto con nosotros

Sprinkler Irrigation Kit For 1 HE (10.000 M2) - (200X50 Meter) Atom 28 (10mm Nozzle) with Pipe Diameter Q90 PE Or PVC - KIT 5B

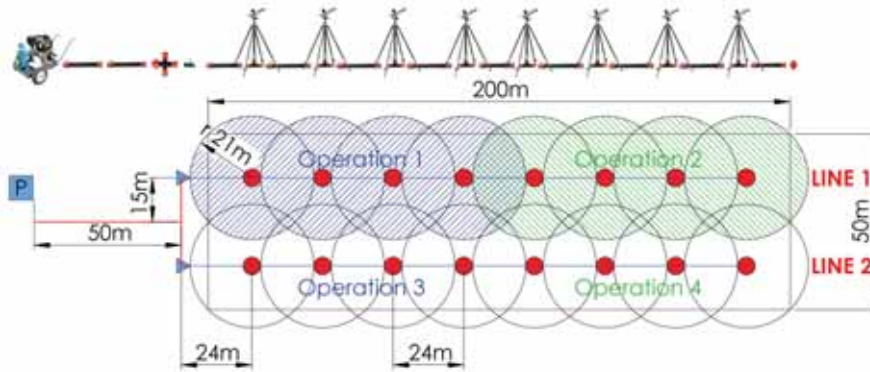

KIT 5B - PE Pipes					KIT 5B - PVC Coupling				
Product Code	Image	Symbol	Description	Quantity	Product Code	Image	Symbol	Description	Quantity
Y00012			Atom 28 (Inlet size 1.5" Female)	34	Y00012			Atom 28 (Inlet size 1.5" Female)	34
Y000014			Pre-EC2 1.5" x PDD Connection Stand (With 1.5" Female / G25 Male Mounting)	34	Y000014			Pre-EC2 1.5" x PDD Connection Stand (With 1.5" Female / G25 Male Mounting)	34
P0022			90° - Q90mm Elbow	4	P0022			90° - Q90mm Elbow	4
P0001			90° - Q90mm - IC Pipe System For 5.8 Meter Pipe Length - PDD	90	P0001			Coupling For 90mm PVC Pipe - Q90 Male (Cross) (Pipe suitable later to be 80mm/85mm Working Pressure 8 bar)	90
P0004			Q90mm / Q90mm Cross TE	1	P0004			Q90mm / Q90mm Cross TE	1
P0006			Q90mm Gasket	100	P0006			Q90mm Gasket	100
P0003			Q75mm Gasket	20	P0003			Q75mm Gasket	20
P0005			Q90mm / Q75mm TE	24	P0005			Q90mm / Q75mm TE	24
P0072			2" - Q90mm Plastic Line Valve	1	P0072			2" - Q90mm Plastic Line Valve	1
			1.5" M / 1.5" F Ball Valve	34				1.5" M / 1.5" F Ball Valve	34
P0012			2" - Q90mm Male End Cap	3	P0012			2" - Q90mm Male End Cap	3

Sprinkler Irrigation Kit for 1HE (9900m2) - 90 Meter X 110 Meter Atom14 WFC & Atom14 PC (4mm X 2.5mm) With 63mm - 2" HDPE Pipe Sprinkler KIT 1A

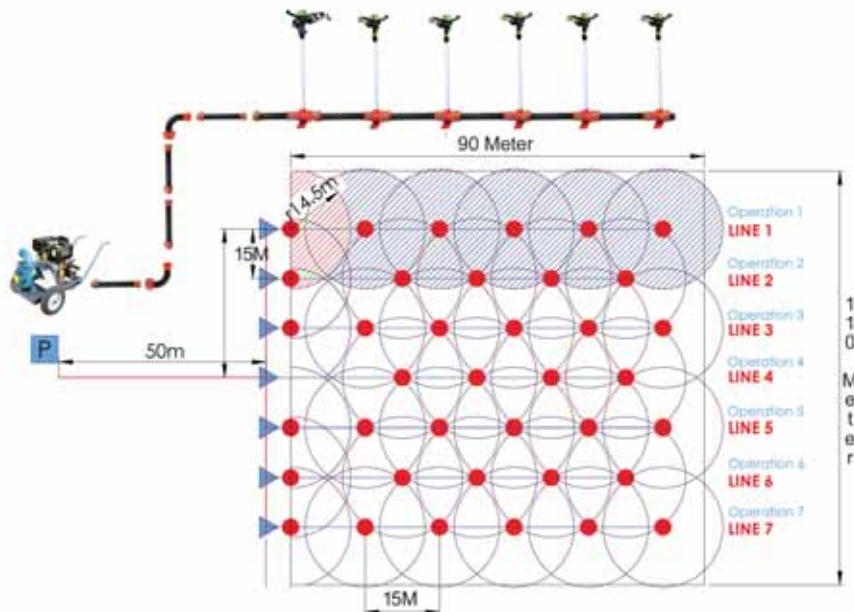

DESCRIPTION OF THE GOODS	QTY. PRICE
SPRINKLER ATOM14 WFC	34
SPRINKLER ATOM14 PC	6
3/4" - 1" Reduction for Atom14 Sprinkler	40
63mm Abot + 100cm PVC Riser	40
63MM Gasket	200
Cross TE 63X63MM	2
TE 63X63MM	7
63MM HDPE PIPE 5 Meter	135
GATE VALVE 2"	7
ELBOW 63MM	8
END PLUG 63MM	6
Aluminium Water Pump Outlet 2"	1

**Sprinkler Irrigation Kit for 1.8HE (18.000 m2) - (300X60 Meter) JET50 18mm Nozzle
with Pipe Diameter 3" HDPE (90mm) Kit 4A3 JET50**

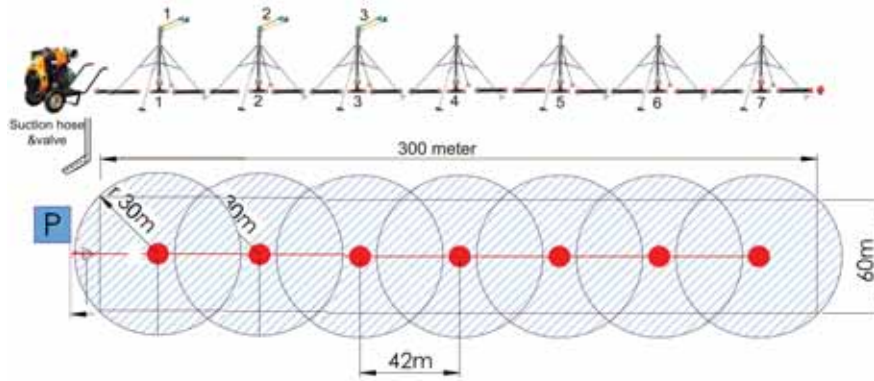

Kit 4A3 JET50				
Product Code	Picture	Symbol	Product Name	Quantity
YZ0007			Yusak JET50 (Inlet Size 2")	3
YZ0006			4 Pod 2" Connection Stand With Quick Coupling (With Q75 Motorspung)	7
PS022			3" - Q90mm Elbow	3
PS003			3" - Q90mm - QC Pipe System For 5.8 Meter Pipe Length - PMS	55
PS004			Q90mm Gasket	75
PS003			Q75mm Gasket	15
PS070M			2" Brass Line Valve (Female Threaded & Female Threaded)	7
PS043			Q90mm / Q75mm TE	7
PS012			3" - Q90mm Male End Cap	2

**Sprinkler Irrigation Kit For 1.5 HE (15.000 M2) - (125X120 Meter) Atom 35 (14mm Nozzle)
with Pipe Diameter Q90 PE Or PVC - KIT 3B**

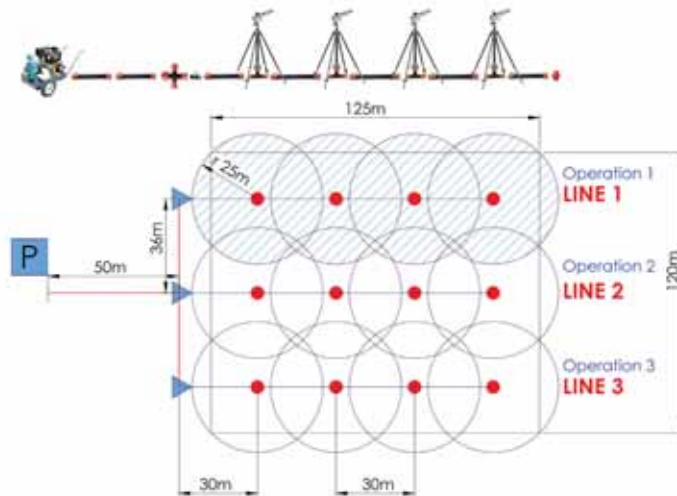

KIT 3B - PE Pipes				
Product Code	Picture	Symbol	Product Name	Quantity
YZ0076-BSP			Atom35 (14mm Nozzle)	12
YZ0020P4			Pro Eco 1.5" Connection Stand & Pod (With Q75 Motorspung)	6
PS022			3" - Q90mm Elbow	4
PS003			3" - Q90mm - QC Pipe System For 5.8 Meter Pipe Length - PMS	90
PS004			Q90mm Gasket	120
PS003			Q75mm Gasket	15
PS072			3" - Q90mm Plastic Line Valve	3
PS08CT			Q90mm / Q90mm Cross TE	1
PS043			Q90mm / Q75mm TE	12
PS012			3" - Q90mm Male End Cap	6

KIT 3B - PVC Coupling				
Product Code	Picture	Symbol	Product Name	Quantity
YZ0076-BSP			Atom35 (14mm Nozzle)	12
YZ0020P4			Pro Eco 1.5" Connection Stand & Pod (With Q75 Motorspung)	6
PS022			3" - Q90mm Elbow	4
PVC11			Coupling for 90mm PVC Pipe - Q90 Male (Cream) (Pipe suitable have to be Coupling for 90mm PVC Pipe - Q90)	90
PVC12			Coupling for 90mm PVC Pipe - Q90 Female (Cream) (Pipe suitable have to be)	90
PS004			Q90mm Gasket	120
PS003			Q75mm Gasket	15
PS070			3" - Q90mm Plastic Line Valve	3
PS08CT			Q90mm / Q90mm Cross TE	1
PS043			Q90mm / Q75mm TE	12
PS012			3" - Q90mm Male End Cap	6





ISO 9001:2015



Turkey

Discover
the potential

Yüzüak Makina İth. İhr. San. Tic. A.Ş. KIRKLARELİ / TURKEY

Tel: +90 288 214 17 43 / Fax: +90 288 212 71 21

sales@yuzuak.com / www.yuzuak.com